



XPLORA 707



RIEJU

FOR EVERYDAY ADVENTURE

OWNER'S MANUAL



INDEX

Important Information	4	Shift lever	42
Special Reminding.....	7	Rear brake pedal	43
Safety Instructions for Motorcycle	9	Side stand.....	43
Vehicle description	12	Tool kit.....	44
Vehicle registration.....	13	Front shock absorber adjustment.....	45
Vehicle delivery (complete upon first delivery)	14	Rear shock absorber adjustment	46
Pre-delivery Inspection (adjustments)	15	Rearview mirror adjustment	50
Technical info	18	Instructions for fuel and oil	50
Location of serial numbers	20	Pre-Driving inspection	52
Chassis identification number	20	Runing in of new vehicle.....	54
Engine identification number	20	Engine running in.....	54
Builder label	21	Tyre running in	55
Main vehicle elements	22	Running in of braking system	55
Dashboard.....	25	Vehicle driving	56
Instrument Adjustment Button	30	Pre driving inspection	56
Mobile Bluetooth function	31	Engine start.....	60
Instructions for use of instruments.....	32	Use of transmission	61
Key.....	32	Riding on a slope.....	61
Power lock	32	Use of brake and parking.....	62
Left handle.....	34	Fuel	63
Right handle	37	Fuel evaporation	64
Refueling.....	40	Catalyst.....	66



Troubleshooting	67	Fuel injector and fuel circuit.....	100
Inspection and maintenance.....	69	Lubrication of parts.....	101
Daily inspection	69	Battery	102
Battery maintenance.....	70	Replacement of Fuse.....	105
Maintenance table	71	Headlight beam adjustment	106
Engine oil level.....	73	Replacement of Light Source	106
Replacement of engine oil and oil filter	74	Use and maintenance instructions of ABS	107
Spark plug	76	Storage and cleaning of vehicles.....	108
Adjustment of the throttle cable.....	77	Modifications and accessories.....	113
Adjustment of the clutch	79	Warranty	114
Adjustment of the engine idling.....	80		
Throttle body.....	81		
Drive chain.....	82		
Brake	85		
Tyre	89		
Seat cushion installation and removal	90		
Maintenance of the air filter	93		
Coolant	95		
Catalytic converter.....	98		
Canister	98		
Installation and removal of the radiator water pipe clamp.....	99		



IMPORTANT INFORMATION

These are the safety alert symbols. Obey all safety messages that follow these symbols to avoid possible injury or death.



WARNING:

It indicates that failure to follow the instructions may result in severe personal injury or even death.



CAUTION:

It indicates that failure to follow the instructions may result in personal injury or equipment damage.



TIP:

Additional information provided by Rieju.



RIEJU S.A. would like to thank you for your trust in our company and congratulate you on an excellent choice.

The **XPLORA 707** model is the result of **RIEJU**, extensive experience in developing high-performance vehicles.

The purpose of this Owner's Manual is to set forth how to use and maintain your vehicle. We ask that you carefully read the instructions and the information provided as follows.

Please remember that the vehicle's lifespan depends on how you use and maintain it. Keeping it in perfect operating condition reduces the cost of repairs.

Please consider this manual an integral part of the vehicle. It must remain with its basic equipment, even in the event of a change in ownership.

For any issues, please see your **RIEJU** dealer, who will be delighted to serve you, or visit **www.riejumoto.com**

Remember that for your vehicle to operate properly, you must always request original replacements.



This manual should be considered a permanent document of the motorcycle. Even when transferring the motorcycle to others, please hand this manual over to the new owner.

No part of this use and maintenance instruction may be reproduced without written permission.



WARNING:

- Drivers and passengers
- This motorcycle is designed to be used by only one driver and one passenger.



WARNING:

- Road conditions for driving
- This motorcycle is suitable for driving on the road.



WARNING:

- Please read this manual carefully. Careful and patient running-in of a new motorcycle enables the motorcycle to run stably at the excellent performance.



SPECIAL REMINDING

Precautions:

- When installing or replacing the battery for the first time, pay attention to the positive and negative terminals. If there is a reverse connection, check whether the fuse is in good condition. However, you should send it to the Service Center for inspection regardless of whether the fuse is in good condition to prevent some electrical components from being damaged due to reverse connection of the battery. If the damaged components continue to work, some unpredictable failures may be caused.
- Before replacing the fuse, turn the key to the  position to prevent the accidental short circuit;
- Do not damage the fuse holder when replacing the fuse. Otherwise, poor contact, damage to components or even fire accidents will occur.

Energy conservation and environment protection:

- The used oil, coolant, gasoline and some cleaning solvents contain toxic substances. Do not discharge them randomly. Please place them in special sealed containers and send them to the recycling center or the local environmental protection service. Do not discard randomly or disassemble waste batteries without authorization, which should be recycled and disposed of by a dealer or qualified department. Waste motorcycles should be sent to the local specialized recycling service for classification and recycling.

Do not modify the vehicle:

- Do not modify the motorcycle or change the location of the original parts arbitrarily. Arbitrary modification will seriously affect the stability and safety of the motorcycle and may cause the motorcycle to fail to work



properly. No unit or individual may assemble a motor vehicle or arbitrarily change its registered construction, structure or characteristics. The Company will not bear all quality problems and consequences (including loss of warranty) caused by the user's own modification without permission or replacement of unauthorized parts and components. Users are requested to comply with the traffic rules when using the motorcycles.

Important reminder:

- After you buy a motorcycle, please equip it with a motorcycle driving helmet that meets the local regulations



WARNING:

- The motorcycle must be equipped with a fuse that meets the requirements before you drive safely. Do not use a fuse of any other specifications other than those indicated in the technical specifications, and it is also prohibited to directly tie or replace it with other conductive objects; otherwise, it will cause damage to other components and result in fire accidents in serious cases.



SAFETY INSTRUCTIONS FOR MOTORCYCLE

Safe driving rules

- Before riding, the motorcycle must be inspected to avoid accidents and damage to parts.
- Drivers must pass the examination of the traffic management department authority and obtain a driver's license that matches the type of vehicle before they can drive it. It is not allowed to lend the motorcycle to people who do not have a driver's license.
- In order to avoid injury from other motor vehicles, the driver must be as conspicuous as possible. To do so, please:
 - Wear bright and eye-catching tight-fitting clothes;
 - Do not get too close to other motor vehicles.
- Strictly abide by the traffic rules and refrain from engaging in lane cutting or competing for road space.
- Do not drive at a speed exceeding the maximum limit of the road section, as accidents are mostly caused by speeding.
- Turn on the turn signal in advance when turning or changing lanes to attract the attention of others.
- Pay special attention to driving at intersections, parking lot entrances and exits, as well as fast lanes.
- Random modification or disassembly of the original motorcycle parts and components will not guarantee the safety of riding, and it is illegal and will affect the motorcycle warranty.
- The accessories must not affect the driving safety and operation performance of the motorcycle, particularly with regard to electrical systems, which can easily lead to danger due to overloading.
- Towing of trailers is strictly prohibited. Towing a trailer on a motorcycle will cause tyre-tyre overload, damage



and malfunction, reduce the braking performance, and adversely affect motorcycle stability and maneuverability, which may result in death or serious injury. Towing a faulty motorcycle will adversely affect the motorcycle stability and maneuverability and may result in death or serious injury.

- It is strictly prohibited to install a sidecar. Driving a motorcycle with a sidecar will cause loss of motorcycle control, resulting in death or serious injury.
- Overload riding is strictly prohibited. Overloading can cause component failure and seriously affect stability, maneuverability, and performance, possibly resulting in death or serious injury.

Protective clothing

- For personal safety, drivers must wear safety helmets, goggles, riding boots, gloves and protective clothing. Passengers also need to wear safety helmets and hold the passenger armrest firmly.
- During riding, the exhaust system will become hot, and it will still be hot after the engine is stopped for a while. Never touch a hot exhaust system.
- Do not wear loose clothing that may be trapped by the control lever, footrests or wheels while driving.

Wear a helmet

- Helmet that meets safety and quality standards is the most important item of protective equipment for driving. The worst traffic accident is head injury. Please be sure to wear a safety helmet, and it is advised to wear protective glasses.



Precautions for driving in rainy days

- Pay special attention to wet and slippery roads in rainy days, because the braking distance is longer. When driving, please avoid paint, manhole cover and greasy road surface to avoid skidding. Be especially careful when passing railway crossings, bars and bridges. When the road condition can not be clearly judged, the driver should slow down.



VEHICLE DESCRIPTION

This motorbike is powered by a single-cylinder, four-stroke, water-cooled engine. Displacement is 698 cubic centimetres, 83x64.5mm.

It is turned on with an electronic flywheel and a AC coil of 140 W.

Steel and friction multi-plate clutch with constant pressure springs, immersed in oil bath.

The motor is anchored to a highly resistant central chassis, with cone roller bearings.

The front suspension is a hydraulic fork with 43-mm diameter bars. Rear suspension is a hydraulic mechanical shock absorber that provides gentle operation.

Front brake is equipped with 320 mm dual disks and rear brake has a single rear disk of 240 mm.



VEHICLE REGISTRATION

Please make a note of the chassis and engine serial numbers, which will help you for all purposes (certificate of characteristics, insurance, registration, etc.).

These numbers will be useful for you for any suggestions or complaints, as well as to order replacement parts.

Chasis serial number (pg 20)

Engine serial number (pg 20)

Delaer seal



VEHICLE DELIVERY (complete upon first delivery)

- USER MANUAL**
Explain the importance of reading it and understanding all the information. Highlight the sections on safety and maintenance practices.
- WARRANTY REGISTRATION CARD**
Complete the necessary information and provide the customer with a copy.
- HANDLING**
Explain how to properly handle the vehicle.
- WARNINGS**
Explain the importance of the warnings to guarantee a long “life” for the vehicle.
- KEYS**
Deliver the complete set. Advise them to make a backup set.
- FIRST INSPECTION**
Explain that an inspection after 1,000 km is important.
- PERIODICAL MAINTENANCE**
Explain the need for periodical maintenance and state that failure to comply with guidelines for check-up and visiting the shop is grounds for “Loss of Vehicle Warranty”.



PRE-DELIVERY INSPECTION (adjustments)

- General appearance**
- Engine**
- Engine oil level
- Chassis**
- No fuel leaks in: Tank output, fuel tap, and supply lines
- Front and rear brake - Bleed, if necessary
- Coolant level, if applicable
- Front, rear mudguard and attachment elements
- Wiring of electrical installation around the steering column
- Alignment of front, rear wheels, and tightening torque of wheel axles
- Spokes of front and rear wheels
- Tyre pressure
- Chain tension
- Checking the equipment**
- Accelerator works and has free play. Adjust if necessary
- Degrease both brake discs
- Battery charged and terminals greased
- Block steering or anti-theft block
- Electric start-up operation



- General condition of front and rear suspension
- Clutch cable properly adjusted
- Operation of fuel cap closure
- General inspection of nuts and screws: Callipers/discs, transmission/pinions, wheel nuts, tilt, engine mounts, exhaust system, shock absorber, gear selector, brake pedal/levers, manifold nuts, etc.

Fuel tank

- Check that the tank is not in contact with the frame

Driving components

- The digital instrument dashboard checks itself when the ignition is turned on
- Adjusting the headlight height
- Brake light when pressing brake levers LH and RH
- Front, rear blinkers and mounting clips
- Horn operation

ON-ROAD TEST, at least 10 km

- Engine and gearbox operation
- Grip on road and suspensions
- No abnormal sounds

AFTER ON-ROAD TEST

- Coolant leaks
- Fuel system, including hoses, clips, and all associated parts where leaks may appear



- Check breakdown codes with diagnostic tool and delete them if applicable

CHECKING FINAL APPEARANCE

Date

Dealer's signature



TECHNICAL INFO

CHASSIS	
Length x width x height	2190x940x1460 mm
Wheelbase	1.505 m
Total mass	243 kg
Front tyre specifications	110/80-19
Rear tyre specifications	150/70-17
Front brake system	ABS disc brakes
Rear brake system	ABS disc brakes

ENGINE	
Type	QJ283MU-A
Displacement	698 cm ³
Max. net power (Full version)	51.5 kW at 8000 rpm
Max. net power (Restricted version)	35.0 kW at 6000 rpm
Max. torque (Full version)	70.0 Nm at 6000 rpm
Max. torque (Restricted version)	58.0 Nm at 5250 rpm
Cylinder bore x stroke	83.0x64.5 mm
Fuel type	E5



ELECTRONIC CONTROL SETTINGS	
Throttle configuration	Mechanical accelerator
ABS	Standard
Deactivate ABS	Standard
Throttle body	Mechanical standard equipment
Side Box and Trunk	Optional

ELECTRIC CONFIGURATIONS	
Lights	Full LED light source
USB charging	Standard
Side stand off status	Standard



LOCATION OF SERIAL NUMBERS

Chassis identification number (1)

This is the number that is die-cut on the right of the steering tube.

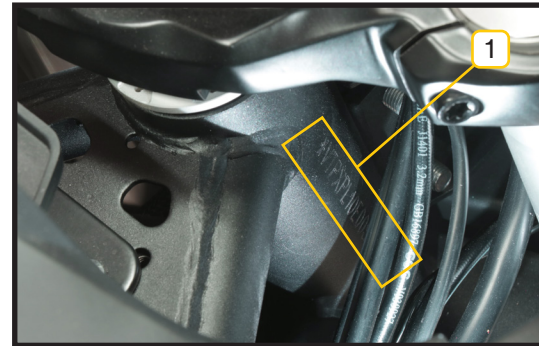

Engine identification number (2)

Engine number is engraved on the lower left-hand side of the engine casing.

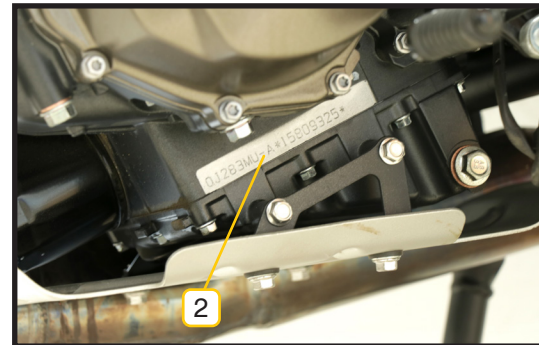



Builder label (3)

Your **RIEJU** has an identification plate detailing: manufacturer, chassis number, type approval number and noise emission level.

Product label is riveted to the right side of the motorbike's steering tube.





MAIN VEHICLE ELEMENTS

1. Rear Wheel ABS Wheel Speed Sensor
2. Front Brake.
3. Shift Lever.
4. Central stand.
5. Side stand.
6. Driver Footrests (left)
7. Seat Cushion Lock.

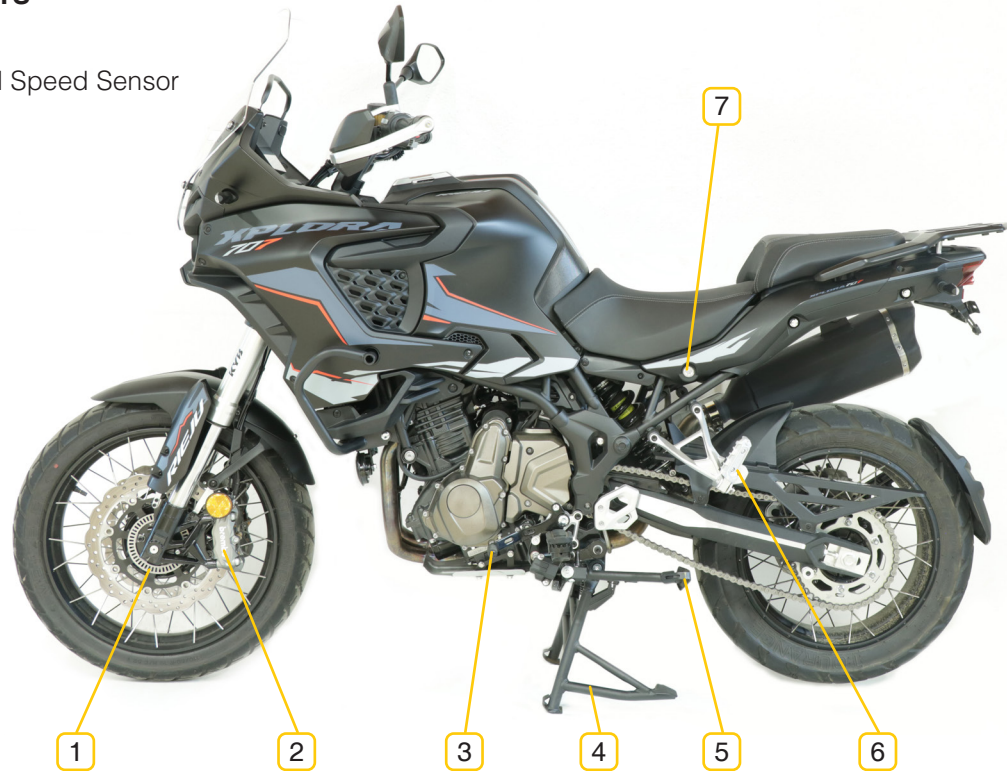



7. Rear Wheel ABS Wheel Speed Sensor.
8. Rear Brake.
9. Passenger Footrests (right)
10. Driver Footrests (right)
11. Rear Brake Pedal.
12. Oil Filler Cap.
13. Rear Brake Fluid Reservoir

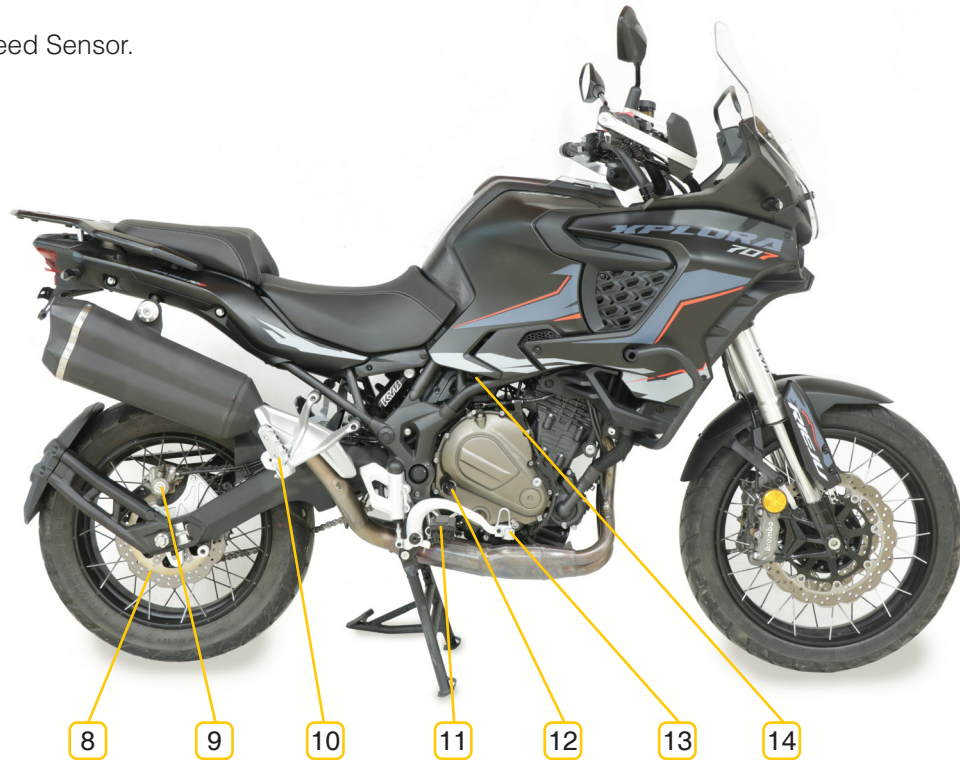

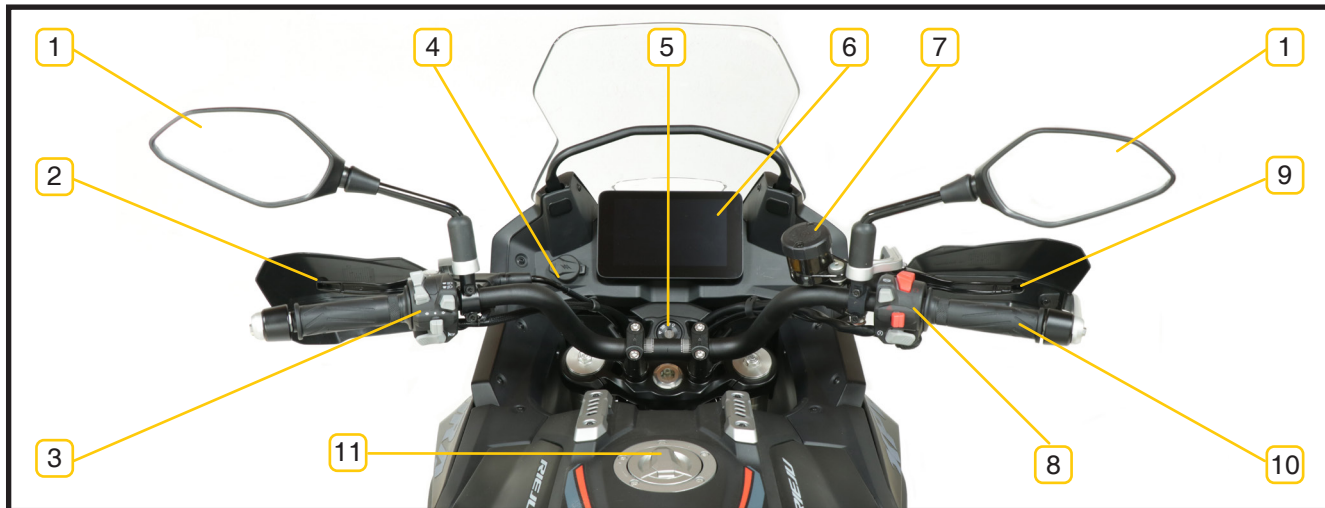

1. Rearview Mirror (left and right)
2. Clutch Handle
3. Left Handle Switch
4. USB Charging Port
5. Ignition Switch
6. Dashboard

7. Front Brake Fluid Reservoir
8. Right Handle Switch
9. Front Brake Handle
10. Throttle Control Grip
11. Fuel Tank



DASHBOARD

1. Incoming/outgoing call display
2. Engine fault indicator
3. Gear indicator
4. High beam indicator
5. Engine oil indicator
6. ABS indicator
7. Bluetooth indicator
8. ABS OFF
9. Fuel indicator
10. Water temperature display
11. Right turn signal light indicator
12. Speedometer
13. Odometer
14. Maintenance reminder
15. Time display
16. Left turn signal light indicator
17. Tachometer

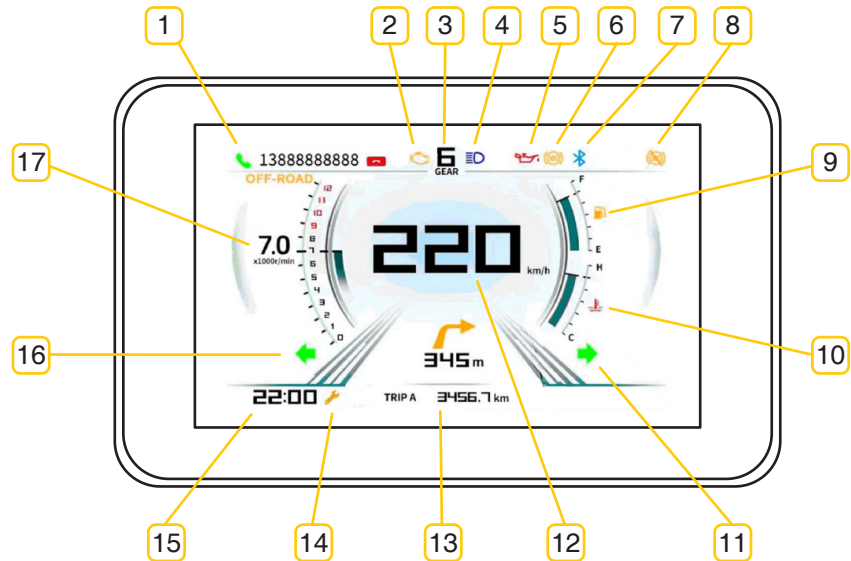



1) Incoming/outgoing call display:

Incoming/outgoing calls can be displayed once the Bluetooth connection is established between the phone and dashboard.

2) Engine fault indicator:

When the key is turned on, the indicator light is on, the oil pump works for 3 seconds, and then the motorcycle is started. If the indicator is off after the motorcycle is started, the motorcycle is normal and has no fault; If the indicator is on, the motorcycle has faults. Similarly, if the indicator light is off during driving, the motorcycle runs normally. If the indicator light is on, the motorcycle has a fault and needs to be stopped for inspection. Please contact your local RIEJU workshop for inspection.

3) Gear indicator:

It indicates the current gear of the motorcycle, with 1, N, 2, 3, 4, 5, 6 indicating that the gear is in 1st, Neutral, 2nd, 3rd, 4th, 5th, 6th, respectively.

4) High beam indicator:

When the headlight high beam light is on, the high beam indicator light will be on.



5) Engine oil indicator:

With the ignition key on but without starting the engine, the engine oil indicator will remain on. When the engine starts and if the oil pressure is correct, the oil indicator will turn off. If the oil indicator remains on, it would indicate incorrect oil pressure and you should stop the vehicle to check oil level. If the oil level is below the recommended level, the oil indicator will turn on to alert pilot and fill-up oil level, avoiding damage to the engine.

6) ABS indicator:

Indicating the working state of ABS, please refer to “Use and maintenance instructions of ABS” for details.

7) Bluetooth indicator:

When a Bluetooth device is connected to the dashboard, the Bluetooth icon will turn on. Otherwise, this icon will remain off.

8) ABS OFF:

When activating OFF ROAD mode in dashboard menu, this indicator will turn on indicating ABS has been deactivated.



TIP:

- Do not turn off ABS function during driving on the road.
- ABS OFF is only available when the selected driving mode is off-road. The ABS function that was previously turned off is automatically activated after the motorcycle is restarted.



9) Fuel indicator:

It indicates the fuel level in the fuel tank. When the fuel tank is full (position F), the fuel level is displayed with 6 bars. When the fuel is low and the fuel level is displayed with 1 bar or less (position E), the last indicating mark of the fuel indicator will flash.

10) Water temperature display:

It indicates the water temperature. Position “C” indicates the temperature is low, and position “H” indicates the temperature is high.

11) Right turn signal light indicator:

When the turn signal light turns to the right, the right turn signal indicator will flash accordingly.

12) Speedometer:

It indicates the current driving speed. The selectable units of driving speed are kilometers per hour (km/h) or miles per hour (mph). Please refer to Instrument Adjustment Button for details.

13) Odometer:

The odometer records the total mileage (TOTAL) and trips (TRIP A, TRIP B) records the distance traveled by the motorcycle since the last reset. The trips (TRIP A, TRIP B) can be reset to zero, and the unit can be selected as per kilometers (km) or miles (miles). See Instrument Adjustment Button for details.

**14) Maintenance reminder:**

See “Inspection and Maintenance” on pg 69 below.

15) Time display:

It indicates the current time. To adjust the time, see Instrument Adjustment Button below for details.

16) Left turn signal light indicator:

When the turn signal light turns to the left, the left turn signal indicator will flash accordingly.

17) Tachometer:

The tachometer indicates the speed of the engine speed.



Instrument Adjustment Button (1)

The instrument adjustment button is located on the left handle switch of the motorcycle. In the main display interface of the dashboard, press and release the “SELECT” button to switch between the odometer (TOTAL) and the trips (TRIP 1, TRIP 2).

When one of the trips is selected (TRIP1 or TRIP2), long press “SELECT” button to reset the trip. .

When odometer is selected (TOTAL), a long press on “SELECT” button will change between metric and imperial units for mileage and speed.

When the speed is zero, press and release the “ENTER” button to enter the main menu page of the dashboard.

Functions such as “INTERFACE”, “CLOCK”, “BRIGHTNESS”, “UNIT”, “LANGUAGE”, “INFORMATION”, “Mobile Bluetooth and “EXIT” can be selected. Press and release “SELECT” to select the function to be adjusted, and then press “ENTER” to confirm. After entering the main menu interface, if there is no button or option selected for 8 8 seconds, it will automatically return to the main screen.

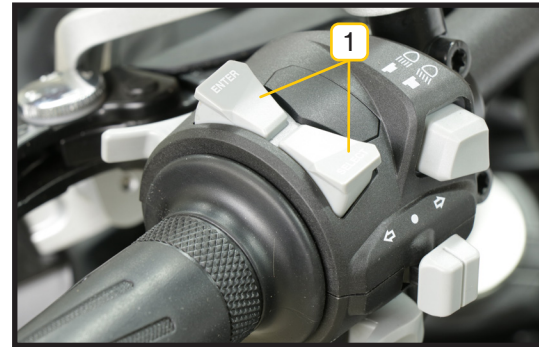



Mobile Bluetooth function

Press and release “ENTER” (1) to enter the main menu page of the instrument, and select “Mobile Bluetooth” to turn on or turn off the Bluetooth function.

When the Bluetooth is successfully paired and connected, the Bluetooth icon on the instrument is always on. After the instrument is connected with the mobile Bluetooth, the instrument can display the incoming/outgoing call interface; you can press “SELECT” to answer the phone and press “ENTER” to hang up the phone.





INSTRUCTIONS FOR USE OF INSTRUMENTS

Key

This motorcycle is equipped with two keys, which can be used to start the motorcycle and unlock all locks. One key is for use, while the other key shall be kept in a safe place.

Press the round button on the key to extend or retract the key head.



Power lock







WARNING:



- Do not hang o-rings or other objects on your key as they may interfere with the rotation of it. Never turn the key while the motorcycle is moving, otherwise the motorcycle will lose control. In order to ensure the safety of riding, do not place objects that hinder the operation of the motorcycle.





“” Mark: Turn the key to the marked position “”, the power supply is cut off, the engine cannot be started, and the key can be taken out.

“” Mark: Turn the key to the marked position “”, the power is on, the engine can be started, and the key cannot be taken out.

“” Position: When the key is at the “” mark position, turn the steering handlebar to the left, press the key downwards and rotate it counterclockwise to the “” position simultaneously. The steering lock extends out of the lock cylinder to lock the motorcycle steering, and the key can be taken out.

**TIP:**

- To prevent theft, always lock the steering and remove the key when parking. After locking, turn the handlebar slightly to confirm whether it is locked. Please do not park in places that obstruct traffic.



Left handle

Clutch handle (1)

When starting the engine or shifting gears, hold the clutch handle to cut off the drive to the rear wheel.





Horn button (2)

When the motorcycle is powered on, press the horn button and the horn beeps.



Headlight high and low beam switch (3)

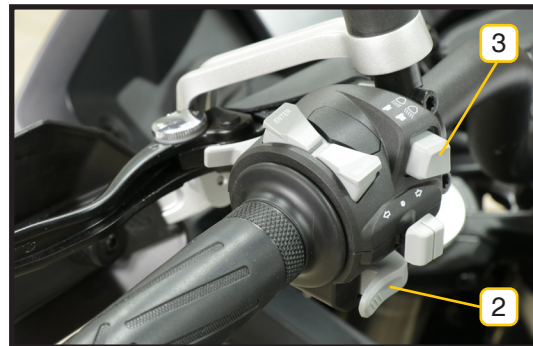
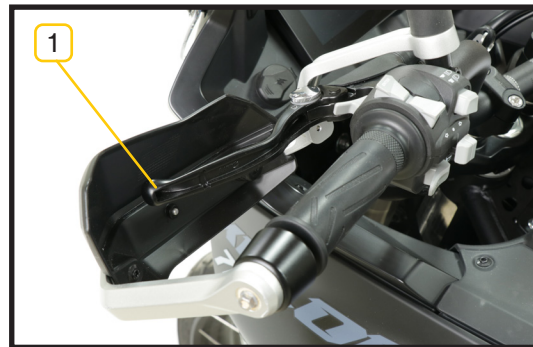

After the light switch on the right handlebar is switched to the “” position, and when the headlight high and low beam switch is switched to the “” position, the high beam headlight will turn on, and the high beam indicator light on the instrument will be also on. When it is switched to the “” position, the low beam headlight will be on.

When riding in an urban area or when there are oncoming vehicles, please switch to the low beam headlight so as not to affect the sight of the other drivers.





Turn signal light switch (4)

Press the turn signal light switch “” or “”, and the left or right turn signal light will flash. At the same time, the turn signal indicator on the dashboard will flash in green accordingly. To deactivate the turn signal, move the turn signal light switch to the middle or press the switch downwards.

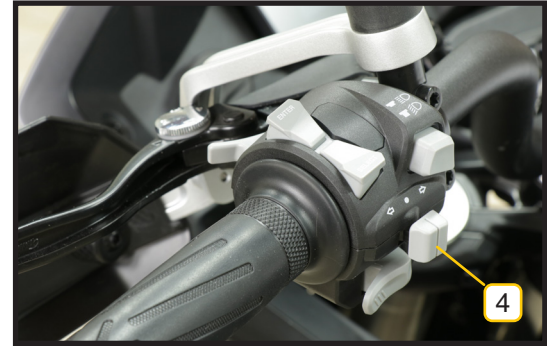

WARNING:

- When changing lanes or turning, turn on the turn signal light and make sure there is no passing vehicle behind. After changing lanes or turning, turn off the turn signal in time so as not to affect the normal driving of other vehicles and avoid accidents.



Overtaking light switch (5)

When crossing or overtaking, press this button continuously and the headlight high beam will flash consecutively to warn the vehicle ahead.

Instrument Adjustment Button (6)

See “Instrument adjustment button” on pg 30 for details.

Clutch handle regulator (7)

For ride comfort, adjust the clutch handle position by adjusting the position of the knob with the ring nut.

Adjustment may be made by choosing one of four positions. Move the clutch handle forward horizontally, and then rotate the ring nut adjuster for alignment with the arrow A to get the desired position. And, the clutch handle is furthest from the grip at Position 1 and nearest from the grip at Position 4.

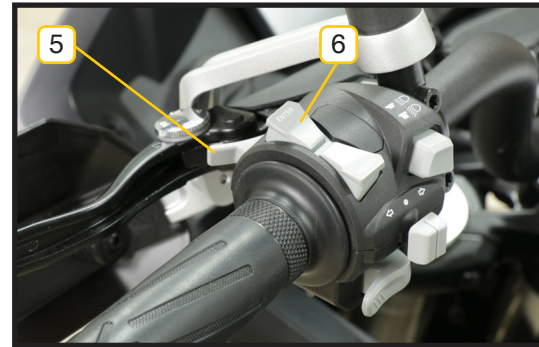



Right handle

Start/Shutdown switch (1)

When the switch is moved to the "⌚" position, the motorcycle is powered on and the engine can be started.

When the switch is moved to the "⊗" position, the motorcycle is powered off, and the engine cannot be started.



WARNING:

- Do not turn the switch from "⌚" to "⊗" during normal riding, as this may damage the engine or exhaust system. Do not use the shutdown switch unless in an emergency.

Front brake handle (2)

For front braking, hold the brake handle of the right handlebar tightly according to the braking emergency conditions.





Throttle control grip (3)

The throttle control grip is used to control the engine speed. To accelerate, turn the grip towards driver's direction, and release or return it clockwise to decelerate.

Hazard warning light button (4)

Press the hazard warning light button, and the front and rear turn signal lights flash simultaneously to remind you of hazard.

Electric start button (5)

Making sure the engine start/shutdown switch is placed at the "○" position, retract the side stand, engage the transmission at neutral position, and press the electric start button "⚡", then the electric motor will run to start the engine.

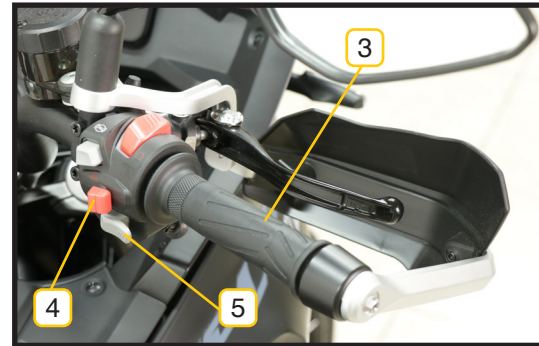

WARNING:

- If the engine cannot be started within 5 seconds, turn the ignition switch to the "⊗" (OFF) position. Wait for 10 seconds until the battery voltage is restored. Then, re-start the engine. If the engine fails to start after several attempts, contact the local RIEJU Service Center for inspection.



ABS button (6)

In ROAD mode, ABS is on by default; when OFF-ROAD mode is set, press and hold the ABS OFF button of the motorcycle for 3S, OFF is displayed on the instrument, then press and hold it again for 3S, ABS is turned on; if OFF-ROAD mode is exited, the ABS button is invalid.





Refueling

When the fuel indicator on instrument is flashing, refuel the fuel tank.

When refueling, first open the dust cover (1) of the fuel tank cap, then insert the fuel tank key and rotate it clockwise to pull and open the fuel tank cap together with the key. To close the fuel tank cap after refueling, please align the fuel tank cap guide pin and press it down to close the fuel tank cap until the key is removed when the lock sound is heard, and then close the dust cover of the fuel tank cap.



WARNING:

- Avoid splashing fuel on the hot engine, as this may cause abnormal operation of the motorbike or lead to dangerous accidents.



**WARNING:**

- When refueling, turn off the engine and turn the ignition key to the “” (OFF) position.
- Don't forget to lock the fuel tank cap after refueling to prevent excessive evaporation of fuel into the atmosphere, which not only wastes energy, but also pollutes the environment.
- Smoking or open flames is strictly prohibited during refueling.
- If the gasoline overflows into the carbon canister and other parts, please go to the nearest RIEJU service center as soon as possible to clean or replace the carbon canister, because too much gasoline into it will lead to premature failure of the activated carbon.
- Regularly check the smoothness of the overflow drain of the fuel tank cap part to ensure smooth drainage and prevent external moisture from entering the inner cavity of the fuel tank.



Shift lever

This type of motorcycle adopts the normally-engaged six-gear international gear (non-cycle) shift mode, and the operation is as shown in the figure. Hold the clutch lever firmly and close the throttle while operating the shift lever.

The neutral position is located between the gear 1 and gear 2. Step down the shift lever from the neutral position to engage the gear 1; every time the shift lever is lifted up, the next high gear is shifted; every time the shift lever is stepped down, the next low gear is shifted. For engaging the neutral gear position, step down or lift up the shift lever to the position between the gear 1 and gear 2.

Because of the ratchet mechanism, it is not possible to raise or lower more than one step at a time.

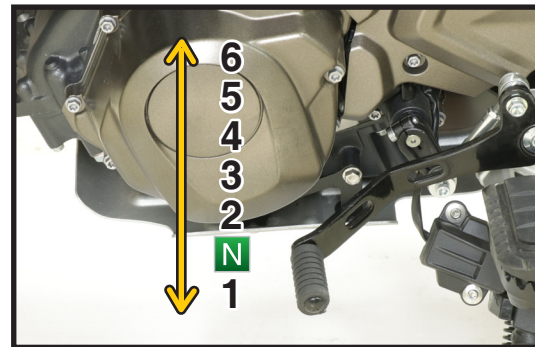

CAUTION:

- When the transmission is placed at the neutral position, the neutral indicator light will come on. Now, still slowly release the clutch to determine whether the transmission is actually at the neutral position.



Rear brake pedal

Engage the rear brake by stepping down the rear brake pedal (as shown in the figure). The brake light will come on when the rear brake is operated.



Side stand

The side stand is located on the left side of the motorcycle. Please deploy it when parking. The side stand has the function of automatic shutdown: When the side stand is in the parking state (the side stand is deployed), the engine cannot be started or automatically shuts down after start if the engine gear position is placed at a position other than neutral. The engine can be started normally only when the side stand is retracted.





TIP:

- Do not use the side stand on an inclined slope or the motorcycle may roll over. Check the position of the side stand before parking.

Tool kit

The tool kit is located on the right side of the rear seat cushion. By using the tool in the tool kit, some simple repairs, adjustments and parts replacement can be carried out on the way.





Front shock absorber adjustment



WARNING:

- The front shock absorber adjustment requires professional knowledge. Please contact your local RIEJU service center to adjust the shock absorber. Unauthorized adjustment may cause a safety accident due to uncoordinated adjustment.

There are 26 adjustment positions in total. The factory adjusts it to the position 11 (using a slotted screwdriver to turn the adjustment bolt clockwise (H direction) to the maximum limit at position 1, then turn it back (S direction) to position 11. This defines the reset resistance at position 11.

Rotate the left and right shock absorber knob clockwise (H direction) with a slotted screwdriver to increase the recovery damping force, and rotate it counterclockwise (S direction) to decrease the recovery damping force.

When the knob of the shock absorber is rotated, it emits a “beep”, indicating that the shock absorber has been adjusted one position. Adjustment requires the left and right shock absorbers to be adjusted to the same level of damping force.



WARNING:

- Do not turn the adjuster beyond limit to avoid damage the shock absorber.

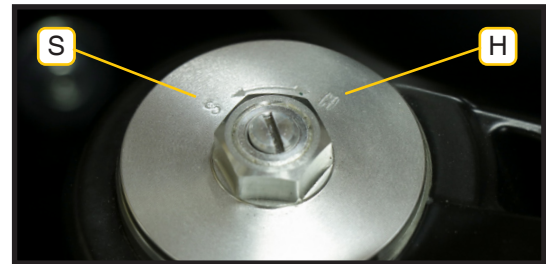



Rear shock absorber adjustment



WARNING:

- Do not turn the adjuster beyond limit to avoid damage the shock absorber. The shock absorber adjustment requires professional knowledge. Please contact your local RIEJU service center to adjust the shock absorber. Unauthorized adjustment may cause a safety accident due to uncoordinated adjustment. The rear shock absorber damping unit contains high pressure nitrogen gas.
- Do not remove, service or improperly operate the shock absorber. Please contact your local RIEJU service center if you have any questions.





Configure I - Rear shock absorber:

Shock absorber adjustment screw (1):

Rotate the shock absorber adjustment knob clockwise with a slotted screwdriver to increase the recovery damping force, and turn it counterclockwise to decrease the recovery damping force. There are 26 positions in total. The factory adjusts it to the position 5 (using a slotted screwdriver to turn the adjustment bolt clockwise (H direction) to the maximum limit at position 1, then turn it back (S direction) to position 5. This defines the reset resistance at position 5.

Adjust the shock absorber in the downward direction with the shock adjuster sleeve to increase the spring preload and the whole shock absorber becomes harder; adjust the shock absorber in the upward direction to decrease the spring preload and the whole shock absorber will become softer.

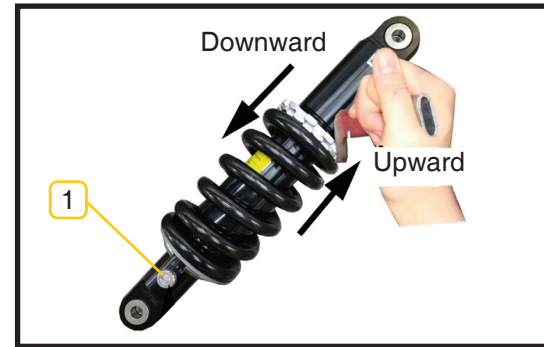



Configure II - Rear shock absorber:

The preload adjustment for compression damping, recovery (rebound) damping, and shock absorber springs (soft, hard) are available.

Compression damping adjustment bolt: (2):

Rotate in the H direction (clockwise) to increase the compression damping value of the rear shock absorber, and Upward rotate in the S direction (counterclockwise) to decrease Downward the compression damping value of the rear shock absorber.

The word COMP on the upper end of the rear shock absorber represents compression damping. There are 23 adjustment positions in total. The factory adjusts it to the position 10 (using a slotted screwdriver to turn the adjustment bolt clockwise (H direction) to the maximum limit at position 1, then turn it back (S direction) to position 10. This defines the reset resistance at position 10.

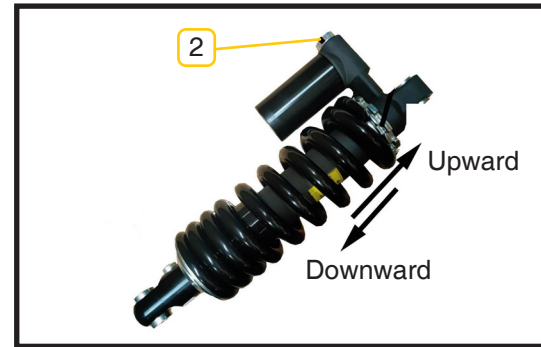



Recovery damping adjustment bolt (3):

Rotate the shock absorber adjustment knob clockwise (H direction) with a slotted screwdriver to increase the recovery damping force, and rotate it counterclockwise (S direction) to decrease the recovery damping force. There are 27 positions in total. The factory adjusts it to the position 3 (using a slotted screwdriver to turn the adjustment bolt clockwise (H direction) to the maximum limit at position 1, then turn it back (S direction) to position 3. This defines the reset resistance at position 3.

Shock absorber spring (soft, hard) preload adjustment: (4):

Adjust the shock absorber in the downward direction (clockwise) with the shock adjuster sleeve to increase the spring preload and the whole shock absorber become hardened; adjust the shock absorber in the upward direction (counterclockwise) to decrease the spring preload and the whole shock absorber is soft.

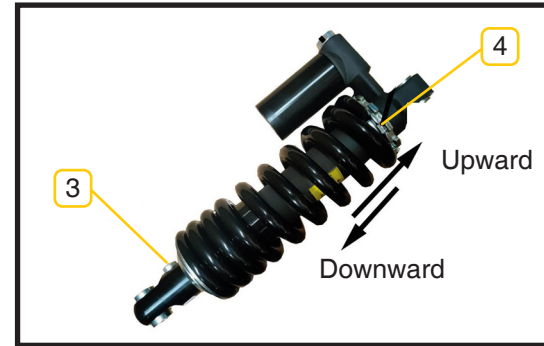



Rearview mirror adjustment

Rotate the frame and lever of the rearview mirror to adjust its angle. Properly adjust the rearview mirror frame and mirror lever until the driver can see the condition behind the motorcycle clearly.

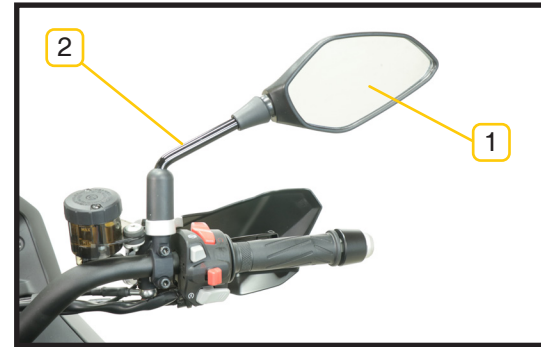

Instructions for fuel and oil

Fuel

Unleaded gasoline should be used.

If the engine makes a slight knocking sound, the fuel may be general grade and must be replaced.



TIP:

- Using unleaded gasoline can prolong the service life of spark plugs.



Engine oil

Please use SN-level high-clarity and high-performance fully synthetic engine oil API SN 10W-50. Damage of any engine part due to the use of another oil which does not meet these specifications will not be covered under warranty and will affect vehicle's warranty.

Oil type	GRO SMART OIL 10W50
----------	---------------------



PRE-DRIVING INSPECTION

Before riding, be sure to inspect the following items. Do not ignore the importance of these inspections. Complete all inspection items before riding.

Inspection item	Key points of inspection
Steering handle	<ol style="list-style-type: none">1) To rotate smoothly.2) To rotate flexibly.3) No axial play or loosening
Brake	<ol style="list-style-type: none">1) Correct stroke of handle and brake pedal.2) No spongy feeling of poor braking.3) No oil leakage.
Tyres	<ol style="list-style-type: none">1) Correct tyre pressure.2) Appropriate tread depth.3) No crack or damage.
Fuel level	Sufficient fuel stock to cover the planned distance.
Light	Operate all lights - headlight, position light, brake light, instrument light, turn signal light, etc.
Indicator light	High beam indicator light, gear position indicator light, and turn signal indicator light
Horn, front brake handle and rear brake pedal	Normal function.



Inspection item	Key points of inspection
Engine oil	Correct oil level.
Accelerator	1) Proper stroke for throttle cable. 2) Smooth acceleration and deceleration.
Clutch	1) Proper stroke for cable. 2) Smooth operation.
Transmission chain	1) Proper tension. 2) Proper lubrication.
Coolant	Coolant level is within the standard range.



RUNING IN OF NEW VEHICLE

Engine running in

Whether in hot or cold state, the engine shall have sufficient idle running time before starting to make the oil flow to all lubricating parts.

During running in, the engine speed at 0 ~ 500km shall not exceed 5000 RPM, and the engine speed at 500 ~ 1000km shall not exceed 7000 RPM.

During the running in period, the gear and speed of the engine should change frequently, and do not run continuously for a long time under a certain gear and speed.

During the running in period, when the engine is running at a fixed low speed (light load), the wear of parts will be intensified and the matching will be poor. Therefore, do not drive at an average speed with light load for a long time.

During running in, avoid sudden acceleration and braking except in case of emergency.

Do not drag the gear to drive, pay attention to downshifting in advance when decelerating, and keep the engine in a comfortable running state all the time.

Long distance riding shall be avoided during running in, so that the engine has enough rest time.



The running in period has a great impact on the service life and fuel consumption of the vehicle, so please read the manual carefully before use (in the initial 500km journey, correct use of the vehicle will enable you to ensure the performance of the vehicle and have fun driving).

Tyre running in

The surface of the new tyre is smooth. If you ride at high speed or bend at this time, it is easy to be dangerous. In order to achieve the maximum grip of the tyre, the running in process is very necessary.

In the first 200km, you can run in the tyre through low-speed curve until all angles of the crown are completely run in.

The bulge on the tyre crown has the risk of causing accidents. The way to avoid the bulge on the tyre crown is tyre running in.

Running in of braking system

In the initial 500 km period, the new brake discs are still in their original state, so their optimal friction level is not reached. As compensation for the loss of braking efficiency, you can control the brake handle with greater force.



CAUTION:

- When running in a new car, the engine speed should change from time to time. Do not drive continuously at a certain speed. The purpose is to properly stress the components to make them fully fit, but do not apply excessive load.



VEHICLE DRIVING

Pre driving inspection

If the vehicle is not inspected before driving, the probability of accident and vehicle damage will be increased. Please pay attention to the following items:

Steering system

- The steering handle turns flexibly without jamming.
- The steering column is not moving or loose.

Throttle

- The throttle cable clearance is correct.
- The throttle operates smoothly without jamming.

**Brake**

- The brake handle and brake pedal operate normally.
- The brake fluid is at the correct level of the brake oil cup.
- The medium pressure point is clear during braking.
- The brake disc and pad shall be free of water and oil stain.

Shock absorber

- Press to return smoothly.

Drive chain

- No excessive wear and damage.
- The chain tension is correct.



Tyre

- The tyre pressure is correct.

- The tread depth is not excessively worn.

- The tread is free of cracks and wounds.

Engine oil

- The oil level is correct.

Cooling system

- The coolant level is correct.

- No coolant leakage.

Lighting

- The headlamp / front position lamp, tail lamp / brake lamp, turn signal lamp, headlamp and instrument lamp can be turned on normally.



Indicator light

- The high beam indicator, neutral indicator and steering indicator controlled by the brake handle switch can indicate and work normally. The oil pressure alarm lamp, EFI fault indicator lamp, water temperature alarm lamp and oil level alarm lamp do not flash or normally light after the engine is started.

Horn

- The function is normal.

Engine shutdown switch

- The function is normal.

Side stand

- It can be retracted and played normally.

Rearview mirrors

- On the whole vehicle, keep the vehicle vertical, and the objects within 10m at the rear end and 4m wide can be clearly seen from the rearview mirrors.
- If not, please adjust the angle of the rearview mirrors.



Engine start

Check whether the engine shutdown switch is in “○” position.

Insert the key into the ignition switch and turn it to the “○” position.

Confirm whether the engine is in the neutral position, and the neutral indicator “N” of the instrument will be on.

After the above conditions are met, hold the clutch with your left hand to ensure safety, and press the electric start button “Ⓢ” with your right hand. At this time, it is not necessary to turn the throttle handle. Release the electric start button immediately after the engine is ignited.

Start the engine and allow the engine to idle until it is fully warmed up.



CAUTION:

- The colder the weather, the longer the engine needs to be preheated. Sufficient preheating can achieve better lubrication and reduce engine wear.
- Please do not let the vehicle idle for a long time. Poor heat dissipation is likely to cause overheating of the engine and damage internal parts.
- In cold environment, to facilitate start-up, the accelerator can be properly rotated while pressing the electric start button.
- The lubrication of the engine only works when the engine is running, so do not let the engine drive the vehicle for a long distance when the engine is stopped.
- After the engine is started, please check whether the indicator light of the instrument is abnormally on or flashing. If so, please shut down the engine immediately and check accordingly.



This series of vehicles are designed with interlocking switches of ignition circuit and starting circuit. The engine can only be started under the following conditions: the gear is in neutral, the ignition switch and flameout switch are in “○” open position, and hold the clutch handle to ensure safety.

**CAUTION:**

- The irritating tail gas emitted by motorcycles contains carbon monoxide, a colorless and odorless highly toxic gas. Do not idle the engine for a long time in poorly ventilated places or rooms without ventilation equipment, so as to avoid the risk of gas poisoning.

Use of transmission

The transmission can ensure that the engine may run smoothly within the normal operating range. The driver should select the most appropriate gear position for the general conditions. Don't slip the clutch to control the motorcycle speed. And preferably, slow down the engine to run within the normal operating range.

Riding on a slope

When climbing a steep slope, the motorcycle will begin to slow down and appear to be underpowered. At this time, the motorcycle should be switched to a low gear so that the engine can resume its normal power output. The gear should be shifted quickly to prevent the motorcycle from losing power for a short time.

When going downhill, the motorcycle should be switched to low gear to facilitate braking. Be careful not to run the engine beyond the required speed range.



Use of brake and parking

To completely turn off the acceleration, release its control grip while using the front and rear brakes evenly. Shift to a low-speed gear position to decelerate.

Before it stops, hold the clutch handle firmly (at the disengaged position) and shift to the neutral position. Observe the neutral indicator light to identify whether it is at the neutral position.



WARNING:

- Use the front and rear brakes evenly. Preferring to use front or rear braking will accelerate brake wear and impair the braking performance. Riding with an excessively worn brake can cause brake failure, possibly resulting in death or serious injury.



TIP:

- The braking system is an important safety part. If the braking system needs to be repaired or replaced, please contact an authorized RIEJU service center. Improper maintenance of the braking system can adversely affect braking performance and potentially result in death or serious injury.

A motorcycle should be parked on a solid and flat ground. Please do not park in a place that blocks traffic.

Rotate the ignition switch to the “” position to shut down the engine. Lock the handlebar to prevent the motorcycle from being stolen. Remove the key from the ignition switch.



Fuel

The fuel consumption parameters you see when you buy a vehicle are the data that the vehicle drives at a constant speed at a certain speed with the least fuel consumption, which is very different from your usual operation, so you will find that the actual fuel consumption is higher than the fuel consumption parameters during actual driving.

- ☒ Driving in urban areas is unfavorable to fuel consumption. Frequent stop and go means that the engine starts frequently.
- ☒ The vehicles often drive at the economic speed. The economic speed of this series of vehicles is 90km / h, the speed is increased from 100km to 140km / h, and the fuel volume is increased by about 20%.
- ☒ Avoid short distance rides. The fuel consumed by starting the vehicle in the first kilometer is more than twice that under normal conditions, because the engine has not reached the optimal operating temperature.
- ☒ Insufficient tyre pressure will increase the rolling resistance of the wheels, thus increasing fuel consumption.
- ☒ Checking and maintaining your vehicle in strict accordance with the maintenance cycle is also an important part of saving fuel.



Fuel evaporation

When the fuel evaporation system fails, please contact **RIEJU** service shop for maintenance. Do not change the fuel evaporation system, otherwise it may not meet the requirements of fuel evaporation emission regulations.

After disassembly and maintenance, check whether all pipelines are well connected and whether the pipeline joints are free of air leakage, blockage, etc; The rubber hose shall be free from extrusion, fracture, damage, etc.

The fuel vapor in the fuel tank is released into the carbon canister through the desorption pipe. When the engine stops working, the fuel vapor is adsorbed by the activated carbon in the carbon canister; When the engine is working, the fuel vapor in the carbon canister is released to the engine combustion chamber through the desorption pipe to participate in combustion, so as to prevent the fuel vapor from being directly discharged into the atmosphere and causing environmental pollution.

At the same time, the adsorption pipe also balances the air pressure in the fuel tank. When the air pressure in the fuel tank is lower than the external atmospheric pressure, the air pressure in the fuel tank can be supplemented through the carbon canister air pipe and adsorption pipe; Therefore, ensure that all pipelines are unobstructed, prevent blockage, extrusion and other phenomena, and ensure that the anti tilt valve is installed correctly, otherwise it may cause damage to the fuel pump or fuel tank, deformation, rupture or other parts.

The fuel evaporation control system works according to the following principles:

- ☒ After the gasoline in the fuel tank is heated, the gasoline evaporates, passes through the dump valve



to the tank end of the carbon tank and is adsorbed by it.

☒ The fresh air is brought into the engine through the throttle pipe to the engine inlet through the purge.



Catalyst

The emission system of the vehicle is equipped with catalyst, which reduce the harmful components of the engine exhaust. Poor operation of the engine will damage the catalyst, so follow the following behavior:

- ☒ Regular maintenance must be carried out according to the provisions in the manual.
- ☒ In case of unstable engine operation, please go to the authorized **RIEJU** dealer for troubleshooting as soon as possible.
- ☒ When the fuel alarm light is on, replenish fuel as soon as possible. Too low petrol level will cause irregular fuel supply.
- ☒ Do not start the engine in the form of a cart or trailer.
- ☒ The ignition can only be switched off at idle speed.



WARNING:

- The catalyst is a very delicate component.
- Unleaded petrol E5 or E10 should be used. The use of other fuels (petrol or diesel) will damage the catalyst and other vital engine components, even if in a very small quantity.

**WARNING:**

- Do not park or drive on inflammables, such as hay, etc. the temperature of the catalyst is very high, which will ignite these objects.

Troubleshooting

The troubleshooting content can help you find the cause of the general problem. Of course, this is only some basic judgment. If it still cannot be eliminated, please send the vehicle to the dealer authorized by **RIEJU** for treatment.

The engine will not start

- Neutral, the flameout switch is in the open position.
- In gear, the flameout switch is in the open position, the clutch is clenched, and the side support is retracted.
- Whether the fuel is sufficient.
- Whether the battery power is sufficient.



Difficult engine start

- ☒ Whether it is in a low temperature environment. If so, please bring a little throttle when starting.
- ☒ Battery power loss.
- ☒ If the oil is too sticky, judge whether the oil needs to be changed.

Engine weakness

- ☒ Check whether the filter element of air filter is clean.
- ☒ Check whether the fuel filter is blocked.
- ☒ Whether it is at high altitude.
- ☒ Incorrect maintenance and adjustment will damage your vehicle without finding the cause of the fault. Such damage cannot enjoy the three guarantees policy of **RIEJU**.
- ☒ If you are not sure of any correct operation, please contact the authorized dealer of **RIEJU**.



INSPECTION AND MAINTENANCE

Daily inspection

After use under harsh conditions, after rain and after car washing, corresponding lubrication shall be carried out. In order to drive safely, maintaining good lubrication of working parts is a necessary operation to delay service life.

Daily inspection and lubrication points are as follows:

- Clutch handle lever.
- Brake handle lever.
- Brake pedal bearing.
- Side support shaft and side support spring hook.
- Main and auxiliary footrest shafts and return springs.
- Drive chain.



WARNING:

- Except that the transmission chain needs to be lubricated with chain oil, it is recommended to lubricate other lubrication points with color lithium grease.

Battery maintenance

The battery is located under the seat cushion. The battery equipped on this bike is a maintenance free battery. It is not necessary to regularly check the position and proportion of electrolyte during the service cycle, but the charging condition should be checked regularly.



WARNING:

- If conditions permit, the battery shall be charged for 30 minutes before the first use, which can effectively prolong the service life of the battery.



Maintenance table

COMPONENT	Obs.	1.000 Km	6.000 Km	12.000 Km	18.000 Km	24.000 Km	30.000 Km
* Fuel pipeline		I	I	I	I	I	I
* Throttle operation		I	I	I	I	I	I
Air filter	Note 1	I	I	R	I	R	I
* Spark plug		Every 24.000 km or every two years					
* Valve clearance		Every 48.000 km: A					
Engine oil		R	I	R	I	R	I
Oil filter		R	I	R	I	R	I
* Cooling system		I	I	I	I	I	I
* Drive chain	Note 3	I	Every 1.000 km: I,L,A				
Brake pad wear			I	I	I	I	I
* Brake system		I, A	I, A	I, A	I, A	I, A	I, A
Headlight beam adjustment			I	I	I		
Clutch unit		I	I	I	I	I	I
Side stand			I	I	I	I	I
* Shock absorber system			I	I	I	I	I
* Nut, bolt and fastener	Note 3	I		I		I	
* Wheels / Rim	Note 3	I	I	I	I	I	I
* Steering gear		I			I		I

I: inspect, clean, adjust, lubricate or replace if necessary / C: clean / R: replace / A: adjust / L: lubricate



*For this item, we suggest that it should be overhauled by the local service center for safety.

Note:1. Motorcycles used in dusty areas should be inspected and repaired more frequently. In particular, the maintenance cycle of the air filter needs to be shortened. The first maintenance is carried out 1000km, and it is recommended to clean/wash the air filter every 6000km.

Note: 2. If the odometer reading exceeds this value, repeat the schedule shown in this table for continuous inspection.

Note: 3. If the motorcycle is often ride on uneven roads or under other harsh conditions, please service it frequently to maintain the good performance of the motorcycle.



- The maintenance schedule may change depending on motorcycle use, driving, environmental conditions, etc...



Engine oil level

Check the engine oil level before starting the engine. When checking the oil level, keep the motorcycle upright on a flat ground and check whether the oil level is between the upper and lower scale marks through the oil level window. When the engine oil level is lower than the lower mark (2), open the upper oil filler cap (1) and add engine oil to the level between the upper and lower scale marks.

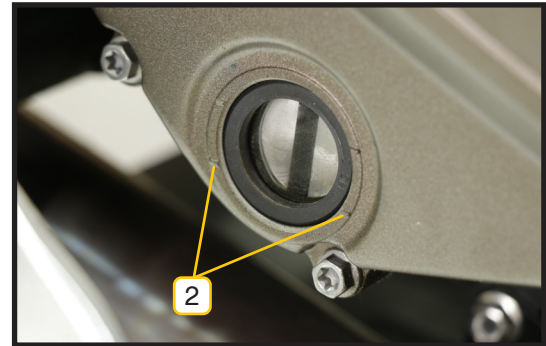



Replacement of engine oil and oil filter



The engine oil shall be replaced when the temperature of the engine is not yet cooled and the body is supported by the support frame (to ensure that the motorcycle is level and the body is upright), so as to ensure that the engine oil can be drained quickly and completely.

The engine oil capacity is 2.6 L, which is about 2.0 L (without replacing the oil filter) or 2.2L (with replacing the oil filter at the same time)

Before draining the oil, put a oil basin below the oil drain position and then remove the drain bolt (1). After completely draining the oil from the tank, reinstall the drain bolt with a torque of 20-25N.m. At the same time, replace the oil filter (2) by following steps:

1. Use the special tool for removing the engine oil filter to clamp the filter and rotate it counterclockwise to remove the filter for replacement.
2. Clean the oil filter and the engine mounting surface with a clean cloth.
3. Use a new oil filter and apply a layer of lubricating oil to the O-ring (A).

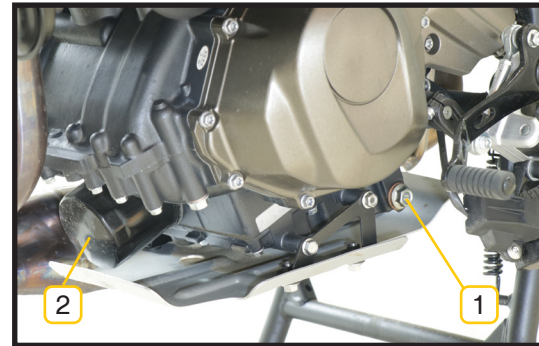



• Please do not remove the O-ring seal of the oil filter, as this will cause incorrect installation of the O-ring seal, which will result in oil leakage or engine damage.

4. Install the new oil filter on the engine by hand until it cannot be screwed, and then use a torque wrench to tighten the oil filter with a torque of 15-20 N.m.
5. Inject about 2.9 L of API SN 10W50 engine oil
6. Install the oil filler cap.
7. Start the engine, keep the engine running at idle speed for several minutes, and then turn off the engine.
8. Check the oil level again and ensure it is between the lower mark and the upper mark. At the same time, check there is no oil leakage in the engine.
9. If the engine oil is splashed, please wipe it clean.





Spark plug

Remove the carbon deposit on the spark plug with a small wire brush or spark plug cleaner at the first 1,000km of driving and every 24,000km thereafter. Readjust the spark plug electrode gap by a spark plug gap thickness measuring piece to keep it between 0.7 and 0.8mm.

The spark plugs should be replaced every 24,000km or after 2 years (whichever comes first).

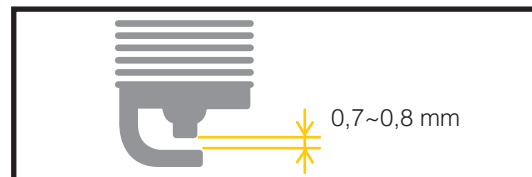

SPARK PLUG TYPE

NGK CR8E

ELECTRODE GAP

0,7~0,8 mm



CAUTION:

- Do not over-tighten the spark plug or allow the threads to be staggered to avoid damage to the threads of the cylinder head. When removing the spark plug, do not allow impurities to enter the engine through the spark plug hole in the cylinder head.



Adjustment of the throttle cable

1. Check whether the throttle control grip can be freely rolled between fully open and fully closed positions, from steering full left lock to full right lock.
2. Measure its free stroke on the flange of the throttle control grip. The standard free stroke shall be 10° - 15° .

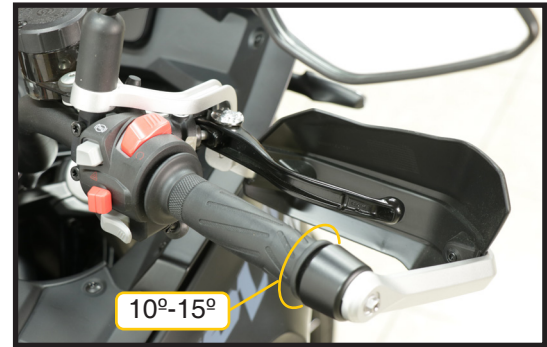

This motorcycle is equipped with a dual-wire structure throttle cable, where the throttle cable A opens throttle and the throttle cable B closes throttle.

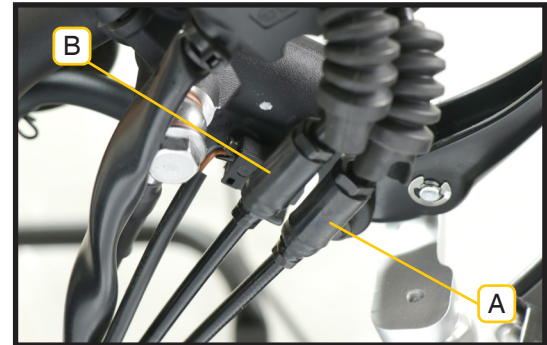



Please follow the steps below to adjust the free stroke of the throttle hand grip:

Throttle cable (A)

1. Remove the throttle cable dust cover.
2. Loosen the lock nut (1).
3. Fully screw in the adjustment nut (2).

Return cable (B)

4. Loosen the lock nut (1).
5. Rotate the adjustment nut (2) to make the free stroke of the throttle control grip is 10° - 15° .
6. Tighten the lock nut (1).
7. Adjust nut (4) so that the throttle hand grip rotates flexibly.
8. Tighten the lock nut (3).

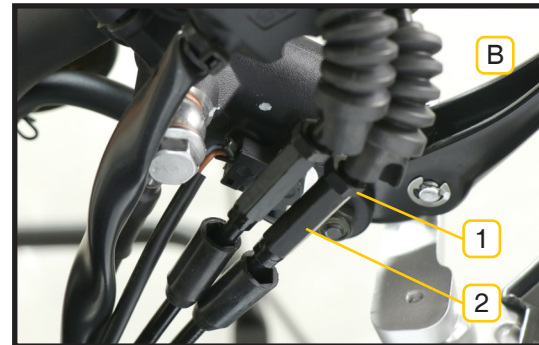
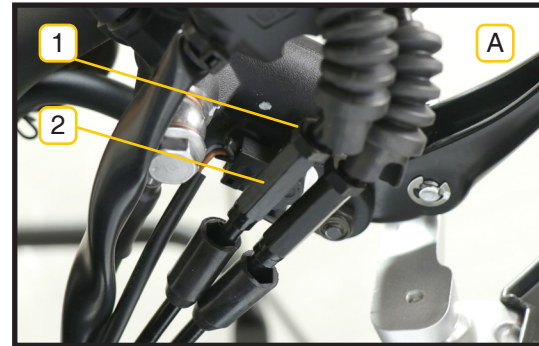



Adjustment of the clutch

The free stroke of the clutch should be 10-20mm before the clutch starts to disengage, based on the end point of the clutch handle. If any abnormality is found, adjust the lever end of the clutch cable as following steps:

1. Remove the clutch cable dust cover.
2. Loosen the lock nut (1).
3. Screw or unscrew the adjusting screw (2) to make the free stroke of the clutch meet the specified requirements.
4. Tighten the lock nut (1).

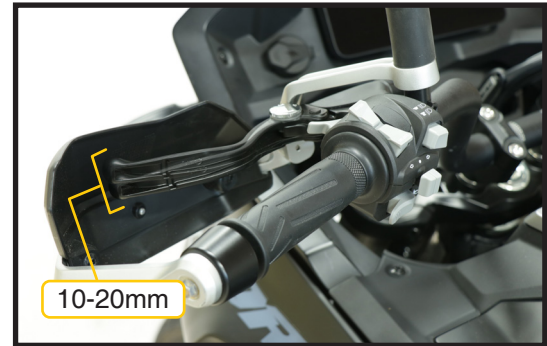



5. If the lever end of the clutch cable cannot meet the free stroke requirements when it is adjusted to the limit position, further adjustment can be made through the lock nut A and the adjusting nut B of the cable and the engine end.

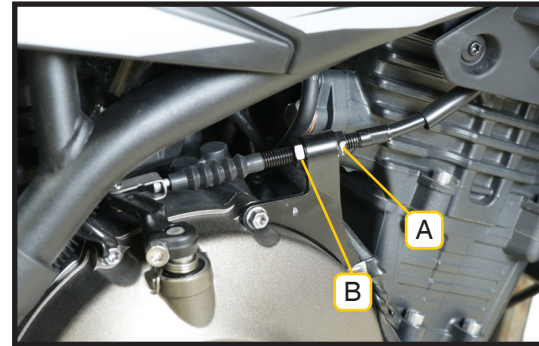

Adjustment of the engine idling

The motorcycle is equipped with a stepper motor that automatically adjusts the idle speed to the appropriate range. If adjustment is required, please contact a professional repair shop or the local Service Center.



Throttle body

The idle speed of the motorcycle will be reduced due to the pollution of the throttle body, therefore, it is recommended to clean the throttle body every 24,000km.

When cleaning the throttle body, disconnect the negative electrode of the battery and the sensor connector installed on the throttle valve; remove the throttle cable, the hose connected to the air filter and the intake manifold, and remove the throttle body.

Spray the cleaning agent on the inner wall of the throttle valve body, and brush off the dust and carbon deposit with a brush.

After cleaning, reverse the operation, install the throttle valve body, and ensure that all components are in place, and try to start the engine successfully.



- Do not allow impurities to block the bypass duct.



Drive chain

The service life of the drive chain depends on proper lubrication and adjustment. Improper maintenance may lead to premature wear of the drive chain and the sprocket. In severe operating conditions, frequent maintenance is necessary.

Adjustment of the drive chain:

For every 1,000km of driving, adjust the drive chain to ensure the sag of the chain is 28-35mm. According to your riding condition, the chain may need to be adjusted frequently.

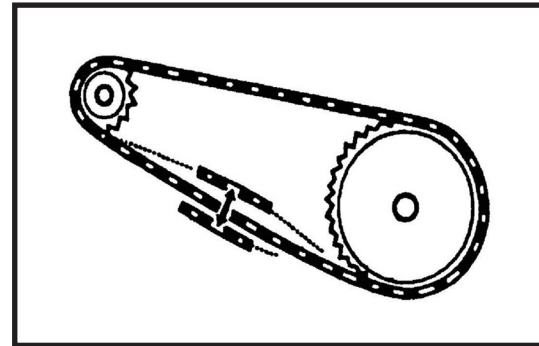

WARNING:

- These recommendations are maximum interval of adjustment. In fact, the chain shall be checked and adjusted before every driving. Excessive loosening of the chain may cause accidents in which the chain is detached or serious damage to the engine.





Adjust the chain as following steps:

1. Support the motorcycle with support stand.
2. Loosen the rear axle nut (1).
3. Loosen the lock nut (2).
4. Turn the adjustment bolt (3) to the right or left to adjust the looseness of the chain. Simultaneously, ensure that the centers of both the front and rear sprockets remain aligned in a straight line. To assist you in this adjustment process, there are reference marks on the swing arm and each chain adjuster, which can be aligned with each other and serve as a reference from one end to the other. After aligning and adjusting the looseness of the chain to 28-35mm, the rear axle nut should be re-fixed for final inspection.

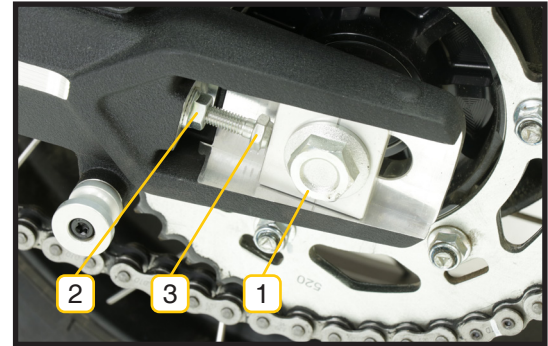

- When a new chain is installed, both sprockets must be checked for wear and replaced if necessary.



During the periodic inspection, the chain shall be inspected for the following conditions:

1. Loose pin
2. Damaged roller
3. Dry and rusty chain joints
4. Twisted or seized chain joints
5. Excessive damage
6. Adjust the loose chain

If the chain has the above problems, then it is very likely that the sprocket will also cause damage to it. Inspect the sprocket for the following conditions:

1. Overly worn gear teeth
2. Broken or damaged gear teeth
3. Loose sprocket fixing nut

Lubrication of the drive chain

It is recommended to prioritize the use of drive chain grease for lubrication, which can be purchased at most motorcycle shops and can be replaced with motor oil or other lubricating oil. Soak each chain joint to allow the grease to penetrate between the chain plates, pins, bushings, and rollers.





Brake

The front and rear wheels of this motorcycle are equipped with wheel disc brakes. Correct braking operation is very important for safe riding. Remember to check the brake system regularly, and this inspection should be carried out by a qualified RIEJU service.

Adjustment of the front and rear brake

1. The free stroke of the front brake handle end should be 10-20 mm.
2. Measure the distance that the rear brake pedal moves before the brake starts to work. (1).

The free stroke should be: 5-15mm.

Adjustment of the rear brake

Adjust the free stroke of the rear brake pedal as following steps:

1. Loosen the nut (1).
2. Screw in or out the top rod (2) to adjust the free stroke of the brake pedal.
3. Tighten the nut (1) after the free stroke meets the specified value.
4. After adjustment, the brake should be free of dragging.

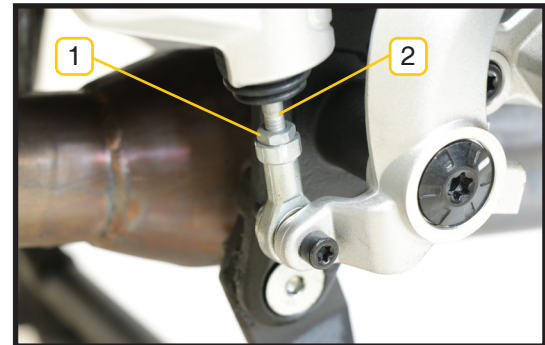
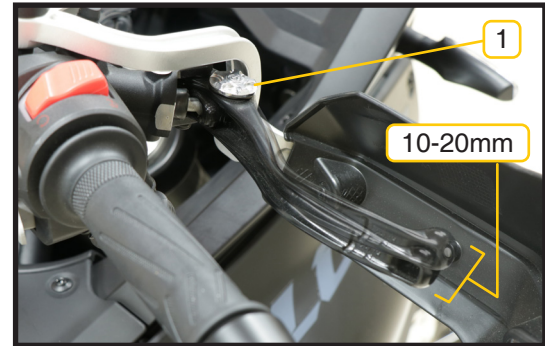



Friction plate

Check whether the friction plates in the brake calipers are worn to the groove bottom mark (1).

If the friction plates reach and exceed the mark, replace them with new ones.

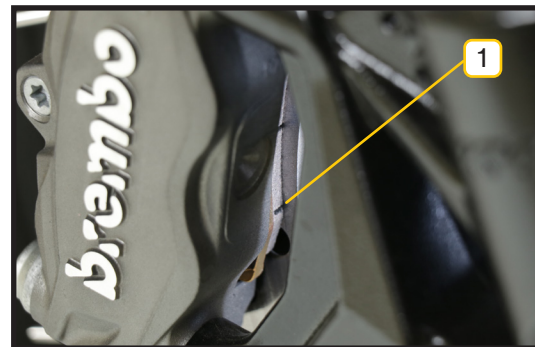



Brake fluid

If the friction plate is worn, the liquid in reservoir will automatically inject into the brake hose and the liquid level will be lowered accordingly. The front brake fluid reservoir is installed above the right handle, and the rear brake fluid reservoir is installed in the middle of the right side of the motorcycle. If the fluid level is below the lower scale line (or the MIN line) in the reservoir, specified brake fluid should be added to ensure that the brake fluid level is between the MIN and MAX lines. During routine maintenance, the brake fluid must be added.



CAUTION:

- DOT4 brake fluid is used for this motorcycle. Do not use the residual fluid of the reservoir or the brake fluid left over from the last maintenance, because the old fluid will absorb the moisture in the air. Be careful not to splash brake fluid on paintwork or plastic surfaces, as it will erode the surface of these substances.



Front brake fluid tank

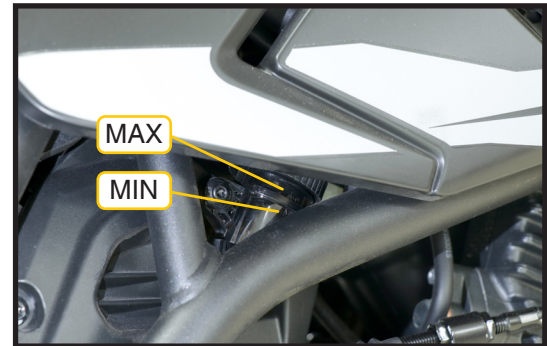

Rear brake fluid tank



Brake system

Inspect the braking system daily as following steps:

1. Inspect the front and rear wheel braking systems for fluid leakage.
2. Keep a certain reactive force for the brake handle and brake pedal.
3. Check the wear of the friction plate. The key to checking the friction plate is to see if the plate has worn down to the bottom of the groove. If it exceeds the bottom line of the groove, the two friction plates should be replaced together.



WARNING:

- If the braking system or friction plate needs to be repaired or replaced, we advise you to ask the contact a RIEJU Service Center to conduct repair or replacement. They are fully equipped and skilled to do the job in the safest and most economical way. When the new disc plate is just replaced, the brake handle shall be grasped and released for several times, so that the friction plate can be fully extended to restore the normal handle support force, and the brake fluid can be stably circulated.



Tyre

The correct tyre pressure will provide maximum stability, riding comfort, and tyre durability. Check the tyre pressure and adjust it if necessary.

Front tyre	220 ±10 kPa (2,2 bar)
Rear tyre	250±10 kPa (2,5 bar)



- Check the tyre pressure when tires are “cold” before riding.

The tread depth on the tread pattern of the tyre crown should be greater than or equal to 0.8 mm. If depth is less than 0.8 mm, the tyre should be replaced with a new one.



WARNING:

- Do not attempt to repair a damaged tyre. Because wheel balance and tyre reliability may be deteriorated.



WARNING:

- Improper tyre inflation will cause abnormal tread wear and therefore threaten driver's safety. Insufficient tyre inflation may cause tyre slippage, disengagement, or even rim damage, which may result in control failure and consequent danger. Riding a motorcycle with a tyre excessively worn is very dangerous, which will adversely affect the ground traction and riding.



Seat cushion installation and removal

Insert the key into the keyhole (1) on the lower left side of the seat cushion, and rotate the key clockwise to open the seat cushion.



Pull up the front of the passenger seat cushion and push it forward to remove it.





After removing the passenger seat cushion, unscrew the fixing screw (2) of the driver seat cushion to remove it.

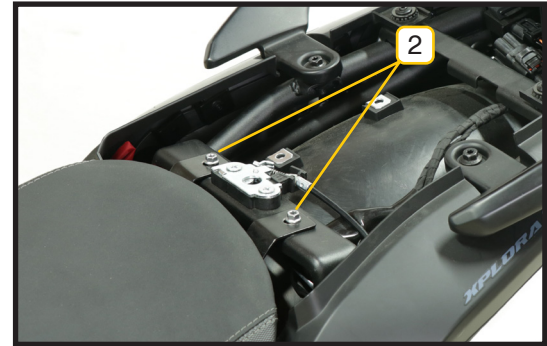

To install the seat, push the seat from the back to the front, making the wings (3) at the front of the seat engage with the limiting plates (4) of the frame.

Insert also the seat centre hook (5) into the housing (6).

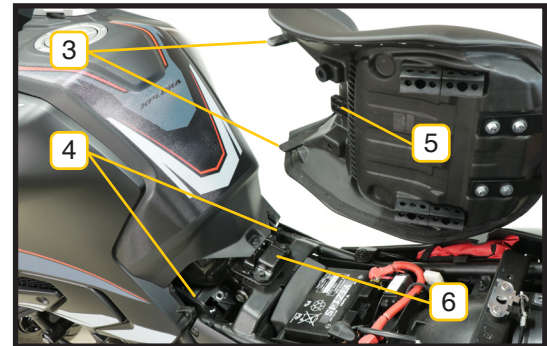



Tighten the seat with the two rear screws (7).

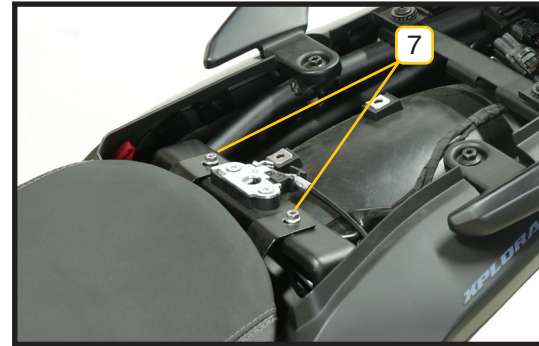

To install the passenger seat cushion, push the cushion forward from the back, allowing the hook (8) on the back of the cushion to engage with the limit plate (9) on the frame. Then, align the locking hook (10) with the lock hole (11) and gently press down on the passenger seat cushion to install it.

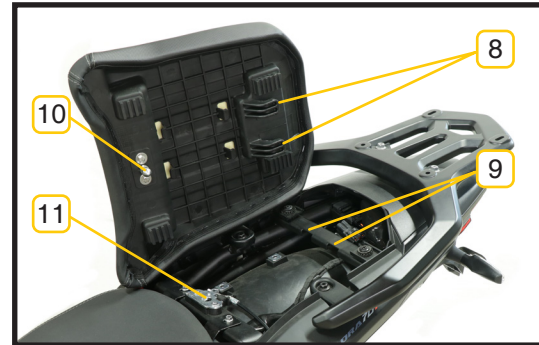



Maintenance of the air filter

The air filter should be maintained regularly, especially when driving in dusty or windy areas.

1. Remove seat (1), left and right front guards (2), left and right-side guards (3), and the fuel tank (4) to access air filter box.
2. Remove the two upper screws (5) from the filter cover.
3. Remove the nine fixing screws (6) of the air filter outer cover to remove it.

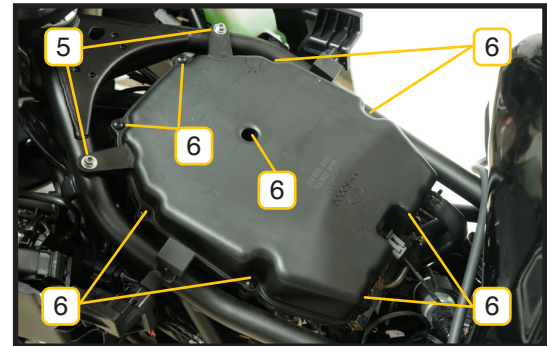
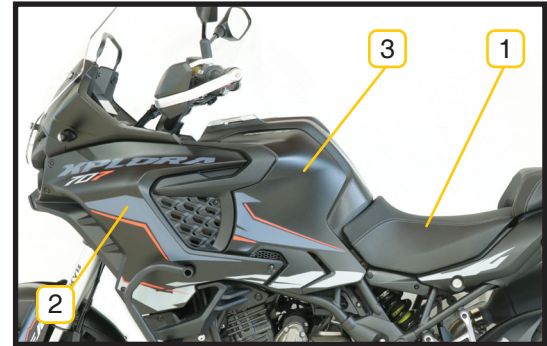



4. Remove the air filter mesh (7).
5. Remove the air filter element (8).
6. Soak the air filter element in clean gear oil until fully saturated, then squeeze out excess oil.
7. Reinstall the components in the reverse order of removal.

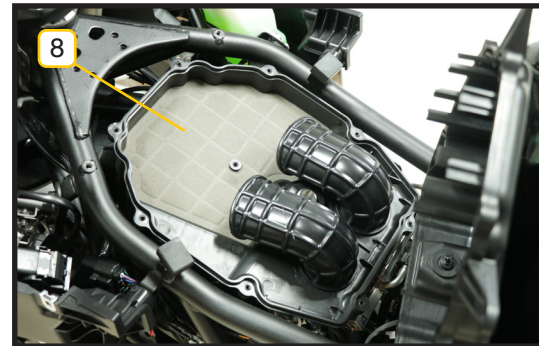
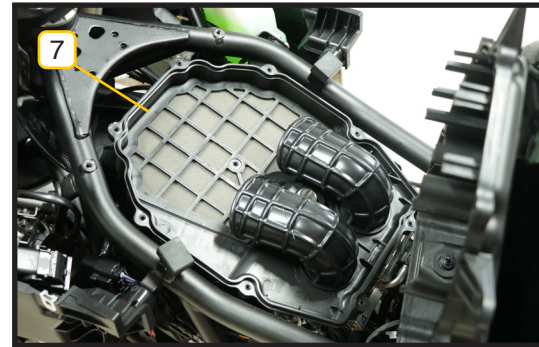

CAUTION:

- Gasoline and low-flash point solvents are highly flammable substances and should not be used for cleaning filter element.



Coolant

Please use genuine anti-freezing coolant.

The use of other coolant/mixtures that do not meet the requirements can cause damage to the engine.

When the new motorcycle leaves the factory, it is already filled with coolant. Check the coolant level in the coolant reservoir during maintenance.

When the coolant becomes turbid or reaches the maintenance interval, please replace the coolant in time.

The filler port (1) for the radiator water tank coolant is located in the right guard at the front of the motorcycle.

1. Remove seat (2), front left and right guards, (3), and left and right-side guards (4).

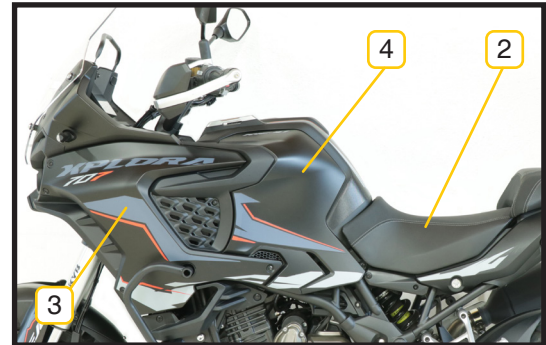
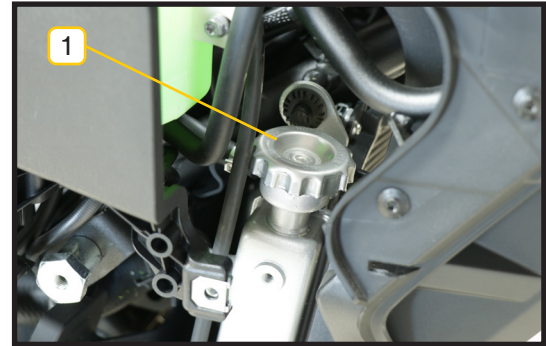



Open the coolant filler cap to fill with the proper amount of coolant.

Reinstall the radiator filler cap after adding.

Check the coolant in the coolant expansion tank only after the engine has been shut down and cooled down.

When checking, make sure that the motorcycle is level and the body is upright.

Observe the coolant capacity in the expansion tank from the front right side of the motorcycle, keeping the coolant capacity between the H and L marks. If the coolant level is lower than the L mark, remove the expansion tank cap plug (5) and add the coolant, or go to the RIEJU service center to add the coolant.

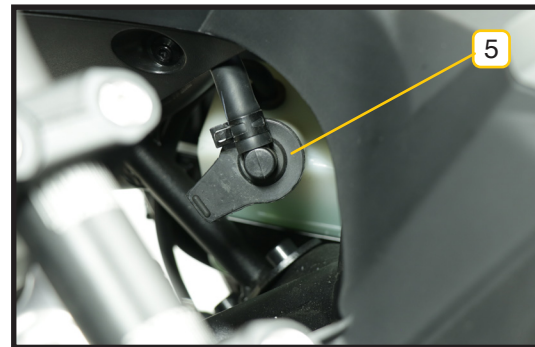

**WARNING:**

- This operation can only be carried out by RIEJU service center. Add the coolant only after the engine has been shut down and cooled down.
- To avoid burning, do not open the coolant filler cap until the engine has cooled down.
- The cooling system is under pressure. In some cases, coolant contains flammable substances and, when ignited, produces an invisible flame. Since the combustion of the leaked coolant will cause severe burns, it is necessary to avoid the leakage of the coolant on the motorcycle parts with high temperature.
- As the coolant is a highly toxic liquid, please avoid contact with and inhalation of it, and keep the coolant away from children and pets. If you inhale coolant, seek medical care immediately. If your skin or eyes accidentally come in contact with coolant, rinse them with water immediately.



Catalytic converter

To meet the need for environmentally friendly emissions, this motorcycle is equipped with a catalytic converter in the silencer.

The catalytic converter contains precious metals as catalysts, which can purify harmful substances in motorcycle exhaust, including carbon monoxide, hydrocarbons and nitrogen oxides.

Since the catalytic converter is very important, a faulty catalytic converter can contaminate the air and impair the performance of your engine. If replacement is required, please use genuine parts or have them replaced by a Service Center.



- The area where the catalytic converter is located is a hot area, so do not touch it.

Canister

This motorcycle model is equipped with fuel evaporation control device: canister.

The canister is located in the middle position above the engine, and it is filled with activated particles that can absorb vapor, which can effectively inhibit the volatilization of excess fuel vapor into the atmosphere, so as to save fuel and protect the environment



Installation and removal of the radiator water pipe clamp

For the radiator hose, the non-regularly removal end is fixed with disposable clamps and the regularly removal end is fixed with plate-type clamps.

After the clamps are removed, the used disposable clamps can not be reused and the plate-type clamps can be reused.

And a special clamp pliers (1) are required to reinstall the clamp (2). Otherwise, the clamp will not be assembled in place, which will cause coolant overflow, resulting in motorcycle failure or personal injury.

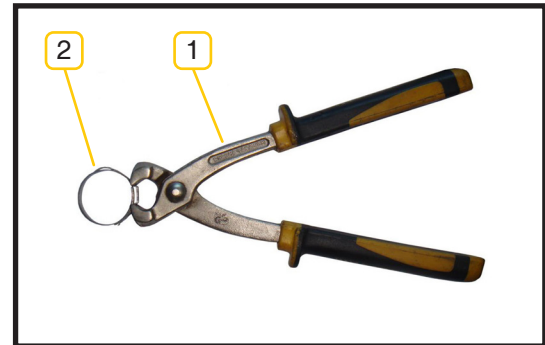
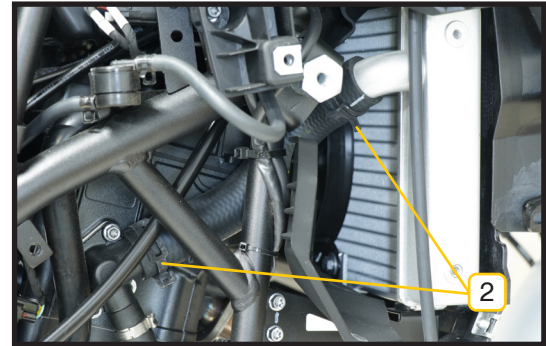



Fuel injector and fuel circuit

The fuel pump (1) is provided with a connector, and fuel is piped through fuel filter (2) from one of the connectors of the fuel pump into the injector (3), which ultimately injects fuel gas into the engine intake pipe.

Please connect the petrol inlet and return pipes as shown in the figure.

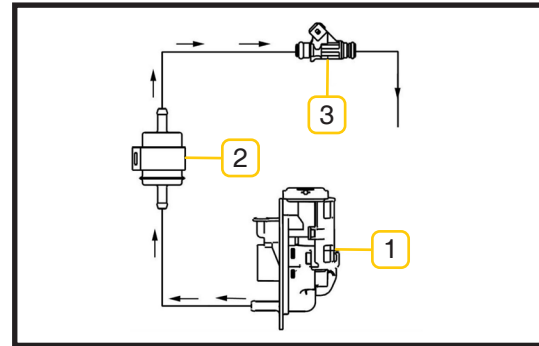



Lubrication of parts

Proper lubrication is very important to maintain the normal operation of each part of the motorcycle, to prolong its service life and to ensure safe driving.

Lubricate your motorcycle after driving for a long mile or if the motorcycle is wet due to rain or washing.

1. Rear brake pedal shaft [Z]
2. Side stand joint and spring hook [Z]
3. Clutch handle (pin shaft) [Y]
4. Shift lever pin shaft [Z]
5. Front brake handle pin shaft [Z]
6. Throttle cable [Y]
7. Center support connector and spring hook [Z]

[Y] Motorcycle lubricant.

[Z] Grease.



Battery

The battery is located under the driver seat cushion. The battery equipped for this motorcycle is a valve-regulated wet-load free maintenance battery. It is strictly prohibited to pry open the shell. There is no need for fluid replacement before and during use.

Read and observe the following precautions before operation:

1. Detect the battery terminal voltage when using for the first time, when the voltage is less than 12.6V, charging is required: charging voltage $14.4 \pm 0.02V$, charging limit current 11.2A, charging until the current drops to 0.2A (or refer to the relevant parameters printed on the surface of the battery). If the temperature of the battery is higher than $45^{\circ}C$ during the charging process, charging should be stopped immediately and recharged after the temperature drops.
2. Red terminal of the battery is for positive level and black terminal of the battery is for negative. Turn off the power supply during wiring, connect the positive electrode first and then the negative electrode; remove the negative electrode first and then the positive electrode

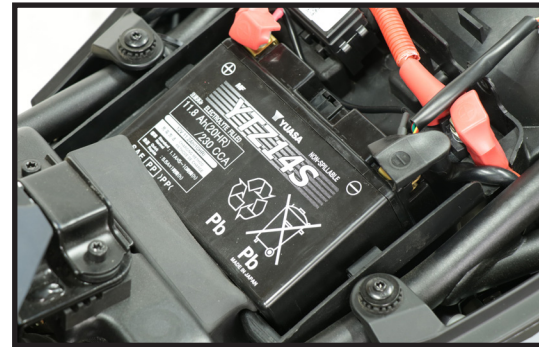



during disassembly.

3. Charging system test: the battery voltage shows 13.5V-15V after starting the whole motorcycle, which means the charging system is normal.

4. Motorcycle leakage current detection: turn off the power supply of the motorcycle, positive or negative pole in series with a multimeter (current gear), the current is less than 5mA, the motorcycle line is no abnormality.

5. When the motorcycle is not used for a long period of time, replenish the electricity once a month, or remove the battery and place it separately, and conduct a voltage test once every three months, and replenish the electricity when the voltage is lower than 12.6V. Storage of batteries in a depleted state is not allowed. When removing the battery for inspection, proceed in the following order:

- a. Turn off the power switch of the motorcycle.
- b. Remove the driver seat cushion.
- c. Remove the mounting screws and battery pressure plate assembly.
- d. Remove the negative terminal (-) and then remove the positive terminal (+)
- e. Take out the battery gently.

Install the battery in reverse order. Connect the positive terminal (+) and then connect the negative terminal (-).



- When reinstalling the battery, make sure that the battery leads are connected correctly. If the battery wires are connected reversely, the circuit system and the battery itself will be damaged. The red line must be connected to the positive terminal (+) and the black line must be connected to the negative terminal (-).
- Be sure to turn off the power switch (key) when checking or replacing the battery.

**WARNING:**

- Battery produce flammable gases during use and charging, so keep them away from open flames or sparks when charging.
- The battery is equipped with sulfuric acid (electrolyte), which is highly corrosive, so it is necessary to prevent the human body, clothes, motorcycles, etc. from contacting the electrolyte, and once contacted, immediately rinse with water, and if it touches the eyes, immediately rinse with a large amount of water and seek medical attention in a timely manner. Electrolyte contact with the skin or eyes may cause severe burns.
- Electrolyte is a toxic substance, so beware of children playing with it. Keep the battery in a safe place out of the reach of children.

**WARNING:**

- During transportation, the battery should not be subjected to strong mechanical impacts and exposure to sun and rain, and should not be placed upside down.
- In the process of disassembly and assembly, the battery should be handled with care to prevent throwing, rolling and heavy pressure.
- It is strictly prohibited to remove the insulating protective cover of the positive and negative terminals of the battery.



Replacement of Fuse

The fuse block is located under the driver seat cushion and next to the battery.

The main fuse is set on the start relay, and the fuse block is located next to the main fuse.

If the fuse is blown frequently, it indicates that there is a short circuit or overload of the circuit. Please contact a RIEJU dealer to repair it in time.



WARNING:

- Before inspecting or replacing the fuse, turn the ignition switch to the “OFF ()” position in order to avoid short circuit and damage to other electrical components.
- Do not use other fuses beyond the specified specifications, as they can have a serious adverse effect on the electrical system, or even burn out the lights or cause a misfire and loss of engine traction, which is very dangerous.

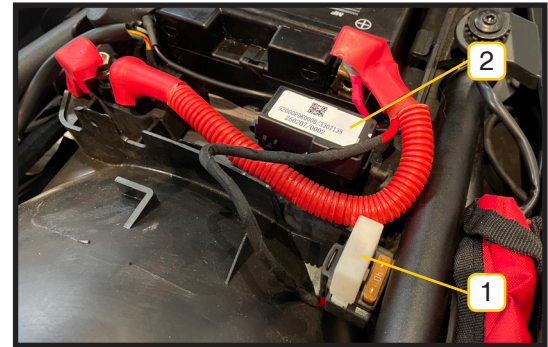

1. Main fuse and backup fuse.
2. Fuse box.



Headlight beam adjustment

Adjust screw (1) to tilt the beam clockwise or counterclockwise to downward or upward; adjust screw (2) to tilt the beam clockwise or counterclockwise to right or left; and the inclination can be $\pm 4^\circ$ from the standard position.



- When adjusting the beam height, the driver should sit on the seat cushion of the motorcycle with two wheels on the ground, and keep the motorcycle in a vertical state for adjustment.

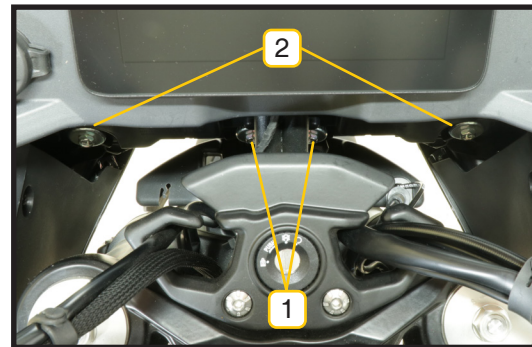

Replacement of Light Source

When replacing a damaged bulb, be sure to use a light bulb with the same rated power. Using bulbs with different wattage ratings may result in an overload of the electrical system and premature failure of the bulbs.

The lighting and light signalling devices of this motorcycle utilize LED, which is not easily damaged. If replacement is necessary, please contact the RIEJU service provider for full lamp replacement.



Use and maintenance instructions of ABS

After the motorcycle is powered on, the ABS indicator on the instrument will be on. When the riding speed reaches 5km/h, the ABS indicator will go out, and the ABS is in normal working condition. If it remains on or flashes when riding, it indicates that the ABS is not working.

If the ABS is not working, please check whether the ABS connector is installed in place and whether the clearance between the ABS wheel speed sensor and the gear ring is within the range of 0.5-1.5mm. If the ABS wheel speed sensor is damaged, the ABS indicator will be on and ABS will not work. As the ABS wheel speed sensor is magnetic, it may attract some metal particles. Please keep the ABS wheel speed sensor clean and free of foreign matters. Adhesion of foreign objects may cause damage to the sensor.

If the ABS system is operating abnormally, please contact the local service center.



STORAGE AND CLEANING OF VEHICLES

Vehicle storage

If your vehicle is not used for a period of time and needs special maintenance, it requires some special materials, equipment and technology. For this reason, it is recommended that you complete these works at an authorized **RIEJU** dealer.

If you want to complete these tasks by yourself, please follow the following methods:

- Completely replace with new oil.
- Block the inlet of the air filter and the exhaust port of the muffler with a rag stained with new engine oil to prevent moist air from entering the engine.
- Completely drain the fuel in the fuel tank.
- Remove the battery, clean the battery surface with neutral soapy water, and clean the oxide on the positive and negative electrodes.
- Store the battery in a room above 0 °C.



- ☒ Adjust the tyre pressure to the specified pressure.
- ☒ Wash the vehicle thoroughly.
- ☒ Spray rubber protective agent on the surface of rubber parts.
- ☒ Finally, cover the vehicle with cloth and park it in a dry and ventilated place.

**WARNING:**

- Charge the removed battery once a month.



How to reactivate the vehicle

- ☒ Clean the vehicle thoroughly.
- ☒ Take out the rags at the air inlet of the air filter and the exhaust port of the muffler.
- ☒ Completely replace the engine oil and oil filter element.
- ☒ Install the battery.
- ☒ Start the vehicle.



Vehicle protection

According to the use, wash the vehicle frequently and try to keep the vehicle clean and dry.

Clean the dirt attached to the vehicle surface as soon as possible, such as bird droppings, asphalt, salt, etc.

Try to use the vehicle cover. Being exposed to direct sunlight for a long period of time will lead to aging and discoloration of external parts.

Vehicle cleaning

Wash the vehicle with cold water.

Wash the vehicle thoroughly with a soft cloth and neutral detergent.

Do not spray the vehicle.

Do not wash the vehicle with high-pressure water.



In rainy days or after washing the bike, there may be a small amount of water mist in the headlamp or steering lamp, this is normal. It only needs to turn on the lamp for a period of time and the water mist will disappear, because the lamps are designed with vent holes.



WARNING:

- The brake capacity of wet brake will decrease. Please test the brake system at low speed repeatedly after washing the car to make it dry quickly.



WARNING:

- The ABS module is located under fuel tank. When cleaning the vehicle, please do not directly flush the ABS module with water to avoid module damage.



WARNING:

- Do not apply de-greaser to the wheel axles or the chain.



WARNING:

- **RIEJU** shall not be held liable for using corrosive de-greaser elements that stain or deteriorate motorcycle elements. **RIEJU** shall not be held liable for possible damages and defects caused by using pressurized water to clean the motorcycle.



MODIFICATIONS AND ACCESSORIES

Use only **RIEJU** genuine parts and accessories.

You can obtain genuine **RIEJU** parts, accessories, and other products through authorized dealerships. At the same time, professionals will introduce you to their installation and use.

The safety, practical performance and matching of these parts and products have passed the test, and will be responsible for these products. On the contrary, it will not be responsible for the unauthorized parts and accessories.

Whenever you plan to replace parts, you should comply with all laws and regulations to ensure that your vehicle will not brake the national requirements for road vehicles and other laws, regulations and specifications.



WARNING:

- Unauthorized modification of performance components such as electronic control system will lead to vehicle damage and accidents.



WARRANTY

Standards regulating manufacturer **RIEJU'S** warranty.

The company **RIEJU** hereby guarantees the end consumer, purchaser of a vehicle manufactured by **RIEJU**, that both the materials and the manufacturing are free from defect, pursuant to the highest quality standards. Consequently, **RIEJU** hereby provides the end purchaser (hereinafter, the “purchaser”), pursuant to the conditions set forth below, with a warranty to repair all material or manufacturing defects found on a new motorcycle at no cost, within the established warranty period and with no limitation in terms of the number of kilometres travelled or the number of hours the vehicle has been operated.

Warranty Period

The warranty period shall be governed by warranty law in the vehicle's country of sale, in force at the time it is sold.



Warranty claims for defects not brought to the attention of a **RIEJU**-authorized dealer before the end of the warranty period shall be excluded.

Purchaser obligations

RIEJU may legitimately reject warranty claims if, and to the extent that:

- a) The purchaser has not brought the vehicle to any of the inspections and/or to undergo maintenance tasks as required in the user manual, or the date set for these inspections or maintenance tasks has passed.



Also excluded from the warranty are defects that appear before the date established for an inspection or maintenance task that never occurred, or that will occur after the established date.

- b) Inspections, maintenance work, or repairs have been conducted by third parties not recognised or authorised by **RIEJU**.
- c) Any maintenance or repair has been conducted in violation of the technical requirements, specifications, and instructions set forth by the manufacturer.
- d) Replacement parts not authorised for use by **RIEJU** have been used in maintenance or repair work on the vehicle, or if, and to the extent that, fuels, lubricants, or other liquids (including, but not limited to, cleaning products) that were not expressly mentioned in the User Manual's instructions have been used on or in the vehicle.
- e) The vehicle has been, in any way, altered or modified or fitted with components other than the components expressly authorised by **RIEJU** as components allowed for the vehicle.
- f) The vehicle has been stored or transported in a way that is contrary to technical requirements.
- g) The vehicle has been used for a special use other than ordinary use, such as competition, racing, or in an attempt to beat a record.
- h) The vehicle has suffered a fall or accident that directly or indirectly causes damages.

Warranty exclusions

The following articles are excluded from the warranty:

- a) Replacements for wear, including, but not limited to, spark plugs, batteries, fuel filters, oil filter elements, chains (secondary), engine output pinions, rear rings, air filters, brake discs, brake pads, clutch disks,



bulbs, fuses, carbon brushes, footrest rubber, tyres, chambers, wires, and other rubber components, exhaust pipe, and washers.

b) Lubricants (for example, oil, grease, etc.) and operational fluids (for example, battery fluid, coolant, etc.).

c) Inspection, adjustment, and other maintenance work, as well as all kinds of cleaning work.

d) Damage to the paint and consequent rust due to external influences, such as rocks, salt, industrial fumes, and other environmental impacts, or inadequate cleaning with inadequate products.

e) Damages caused by defects, as well as expenses caused directly or indirectly by the defects (for example, communications expenses, lodging expenses, car hire expenses, public transport expenses, recovery vehicle expenses, emergency messenger expenses, etc.) as well as other financial harm (for example, caused by loss of use of a vehicle, lost income, lost time, etc.).

f) Acoustic or aesthetic circumstances that do not significantly affect conditions for use of the motorcycle (for example, small or hidden imperfections, normal noise or vibration in use, etc.).

g) Circumstances due to vehicle ageing (for example, fading of painted surfaces or metal coating).

Miscellaneous

a) If repair of the defect or replacing the part is disproportionate, **RIEJU** shall be entitled to decide, at its sole discretion, whether to repair or replace the defective parts. Ownership over the replaced parts, if applicable, shall be held by **RIEJU**, with no other consideration. The dealer authorised by **RIEJU** whom has been entrusted to repair defects shall not be authorised to make binding statements on **RIEJU'S** behalf.

b) If there is doubt as to whether there is a defect or a visual or material inspection is required, **RIEJU** reserves



the right to require that the parts being claimed under the warranty be sent to it, or to request that a **RIEJU** expert examine them. Any additional warranty obligations for replaced parts at no cost or for any services provided at no cost under this warranty shall be excluded. The warranty for replaced components during the warranty period shall end on the expiry date of the warranty period of the respective product.

c) If a defect cannot be repaired and its replacement is disproportionate for the manufacturer, the consumer under warranty shall be entitled to cancellation of the contract (payment of a compensation) or partial reimbursement of the purchase price (discount) instead of motorcycle repair.

d) The purchaser's warranty claims under the purchase-sale contract with the authorised dealer shall not be affected by this warranty. This warranty shall not affect the purchaser's additional contractual rights under the general business conditions of the authorised dealer. However, said additional rights may only be claimed with the authorised dealer.

e) If the purchaser resells the product during the warranty period, the terms and conditions of this warranty shall continue to exist under their current scope, such that rights to claim pursuant to this warranty under the terms and conditions governed by this document shall be transferred to the new owner of the motorcycle.



RIEJU

FOR EVERYDAY ADVENTURE